

ONKYO®

Contents

Before Using Your DVD Player 2

Getting Started

Basic Playback

Advanced Playback

Function Setup

Others

DVD Player

DV-S535

Instruction Manual

Thank you for purchasing the ONKYO DVD Player. Please read this manual thoroughly before making connections and turning on the power. Following the instructions in this manual will enable you to obtain optimum performance and listening enjoyment from your new DVD Player. Please retain this manual for future reference.



WARNING:

TO REDUCE THE RISK OF FIRE OR ELECTRIC SHOCK, DO NOT EXPOSE THIS APPLIANCE TO RAIN OR MOISTURE.

CAUTION:

TO REDUCE THE RISK OF ELECTRIC SHOCK, DO NOT REMOVE COVER (OR BACK). NO USER-SERVICEABLE PARTS INSIDE. REFER SERVICING TO QUALIFIED SERVICE PERSONNEL.



WARNING
RISK OF ELECTRIC SHOCK
DO NOT OPEN

AVIS
RISQUE DE CHOC ELECTRIQUE
NE PAS OUVRIR



The lightning flash with arrowhead symbol, within an equilateral triangle, is intended to alert the user to the presence of uninsulated "dangerous voltage" within the product's enclosure that may be of sufficient magnitude to constitute a risk of electric shock to persons.



The exclamation point within an equilateral triangle is intended to alert the user to the presence of important operating and maintenance (servicing) instructions in the literature accompanying the appliance.

Important Safeguards

1. **Read Instructions** – All the safety and operating instructions should be read before the appliance is operated.
2. **Retain Instructions** – The safety and operating instructions should be retained for future reference.
3. **Heed Warnings** – All warnings on the appliance and in the operating instructions should be adhered to.
4. **Follow Instructions** – All operating and use instructions should be followed.
5. **Cleaning** – Unplug the appliance from the wall outlet before cleaning. The appliance should be cleaned only as recommended by the manufacturer.
6. **Attachments** – Do not use attachments not recommended by the appliance manufacturer as they may cause hazards.
7. **Water and Moisture** – Do not use the appliance near water –for example, near a bath tub, wash bowl, kitchen sink, or laundry tub; in a wet basement; or near a swimming pool; and the like.
8. **Accessories** – Do not place the appliance on an unstable cart, stand, tripod, bracket, or table. The appliance may fall, causing serious injury to a child or adult, and serious damage to the appliance. Use only with a cart, stand, tripod, bracket, or table recommended by the manufacturer, or sold with the manufacturer. Any mounting of the appliance should follow the manufacturer's instructions, and should use a mounting accessory recommended by the manufacturer.
9. An appliance and cart combination should be moved with care. Quick stops, excessive force, and uneven surfaces may cause the appliance and cart combination to overturn.
10. **Ventilation** – Slots and openings in the cabinet are provided for ventilation and to ensure reliable operation of the appliance and to protect it from overheating, and these openings must not be blocked or covered. The openings should never be blocked by placing the appliance on a bed, sofa, rug, or other similar surface. The appliance should not be placed in a built-in installation such as a bookcase or rack unless proper ventilation is provided. There should be free space of at least 20 cm (8 in.) and an opening behind the appliance.
11. **Power Sources** – The appliance should be operated only from the type of power source indicated on the marking label. If you are not sure of the type of power supply to your home, consult your appliance dealer or local power company.
12. **Grounding or Polarization** – The appliance may be equipped with a polarized alternating current line plug (a plug having one blade wider than the other). This plug will fit into the power outlet only one way. This is a safety feature. If you are unable to insert the plug fully into the outlet, try reversing the plug. If the plug should still fail to fit, contact your electrician to replace your obsolete outlet. Do not defeat the safety purpose of the polarized plug.
13. **Power-Cord Protection** – Power-supply cords should be routed so that they are not likely to be walked on or pinched by items placed upon or against them, paying particular attention to cords at plugs, convenience receptacles, and the point where they exit from the appliance.
14. **Lightning** – For added protection for the appliance during a lightning storm, or when it is left unattended and unused for long periods of time, unplug it from the wall outlet and disconnect the antenna or cable system. This will prevent damage to the appliance due to lightning and power-line surges.
15. **Overloading** – Do not overload wall outlets, extension cords, or integral convenience receptacles as this can result in a risk of fire or electric shock.
16. **Object and Liquid Entry** – Never push objects of any kind into the appliance through openings as they may touch dangerous voltage points or short-out parts that could result in a fire or electric shock. Never spill liquid of any kind on the appliance.
17. **Servicing** – Do not attempt to service the appliance yourself as opening or removing covers may expose you to dangerous voltage or other hazards. Refer all servicing to qualified service personnel.
18. **Damage Requiring Service** – Unplug the appliance from the wall outlet and refer servicing to qualified service personnel under the following conditions:
 - A. When the power-supply cord or plug is damaged,
 - B. If liquid has been spilled, or objects have fallen into the appliance,
 - C. If the appliance has been exposed to rain or water,
 - D. If the appliance does not operate normally by following the operating instructions. Adjust only those controls that are covered by the operating instructions as an improper adjustment of other controls may result in damage and will often require extensive work by a qualified technician to restore the appliance to its normal operation,
 - E. If the appliance has been dropped or damaged in any way, and
 - F. When the appliance exhibits a distinct change in performance – this indicates a need for service.
19. **Replacement Parts** – When replacement parts are required, be sure the service technician has used replacement parts specified by the manufacturer or have the same characteristics as the original part. Unauthorized substitutions may result in fire, electric shock, or other hazards.
20. **Safety Check** – Upon completion of any service or repairs to the appliance, ask the service technician to perform safety checks to determine that the appliance is in proper operation condition.
21. **Wall or Ceiling Mounting** – The appliance should be mounted to a wall or ceiling only as recommended by the manufacturer.
22. **Heat** – The appliance should be situated away from heat sources such as radiators, heat registers, stoves, or other appliances (including amplifiers) that produce heat.

PORTABLE CART WARNING



S3125A

Precautions

This unit contains a semiconductor laser system and is classified as a "CLASS 1 LASER PRODUCT." So, to use this model properly, read this Instruction Manual carefully. In case of any trouble, please contact the store where you purchased the unit. To prevent being exposed to the laser beam, do not try to open the enclosure.

CAUTION:

VISIBLE LASER RADIATION WHEN OPEN AND INTERLOCK FAILED OR DEFEATED. DO NOT STARE INTO BEAM.

CAUTION:

THIS PRODUCT UTILIZES A LASER. USE OF CONTROLS OR ADJUSTMENTS OR PERFORMANCE OF PROCEDURES OTHER THAN THOSE SPECIFIED HEREIN MAY RESULT IN HAZARDOUS RADIATION EXPOSURE.

The label on the right is applied on the rear panel except for USA and Canadian models.

**"CLASS 1 LASER
PRODUCT"**

1. This unit is a CLASS 1 LASER PRODUCT and employs a laser inside the cabinet.
2. To prevent the laser from being exposed, do not remove the cover. Refer servicing to qualified personnel.

For U.S. model

The laser is covered by a housing which prevents exposure during operation or maintenance. However, this product is classified as a Laser Product by CDRH (Center for Devices and Radiological Health) which is a department of the Food and Drug Administration. According to their regulations 21 CFR section 1002.30, all manufacturers who sell Laser Products must maintain records of written communications between the manufacturer, dealers and customers concerning radiation safety. If you have any complaints about instructions or explanations affecting the use of this product, please feel free to write to the address on the back page of this manual. When you write us, please include the model number and serial number of your unit.

In compliance with Federal Regulations, the certification, identification and the period of manufacture are indicated on the rear panel.

FCC INFORMATION FOR USER

CAUTION:

The user changes or modifications not expressly approved by the party responsible for compliance could void the user's authority to operate the equipment.

NOTE:

This equipment has been tested and found to comply with the limits for a Class B digital device, pursuant to Part 15 of the FCC Rules. These limits are designed to provide reasonable protection against harmful interference in a residential installation. This equipment generates, uses and can radiate radio frequency energy and, if not installed and used in accordance with the instructions, may cause harmful interference to radio communications. However, there is no guarantee that interference will not occur in a particular installation. If this equipment does cause harmful interference to radio or television reception, which can be determined by turning the equipment off and on, the user is encouraged to try to correct the interference by one or more of the following measures:

- Reorient or relocate the receiving antenna.
- Increase the separation between the equipment and receiver.
- Connect the equipment into an outlet on a circuit different from that to which the receiver is connected.
- Consult the dealer or an experienced radio/TV technician for help.

For Canadian model

This class B digital apparatus complies with Canadian ICES-003.

For models having a power cord with a polarized plug:

CAUTION: TO PREVENT ELECTRIC SHOCK, MATCH WIDE BLADE OF PLUG TO WIDE SLOT, FULLY INSERT.

Modele pour les Canadien

Cet appareil numérique de la classe B est conforme à la norme NMB-003 du Canada.

Sur les modeles dont la fiche est polarisee:

ATTENTION: POUR EVITER LES CHOCS ELECTRIQUES, INTRODUIRE LA LAME LA PLUS LARGE DE LA FICHE DANS LA BORNE CORRESPONDANTE DE LA PRISE ET POUSSER JUSQU'AU FOND.

Precautions

1. Regional Restriction Codes (Region Number)

Regional restriction codes are built into DVD players and DVD videos for each sales region. If the regional code of the DVD Player does not match one of the regional codes on the DVD video, playback is not possible.

The regional number can be found on the rear panel of the DVD Player. (e.g.  for Region 1)

2. About This Manual

This manual explains the basic procedures for operating the DVD Player. Some DVD videos do not support the full potential of the DVD technology. Your DVD Player may therefore not respond to all operating commands. Refer to instruction notes on discs.

A “” mark may appear on the TV screen during operation. It means that the operation is not permitted by the DVD player or the disc.

3. Warranty Claim

You can find the serial number on the rear panel of the unit. In case of warranty claim, please report this number.

4. Recording Copyright

Recording of copyrighted material for other than personal use is illegal without permission of the copyright holder.

5. Power

WARNING

BEFORE PLUGGING IN THE UNIT FOR THE FIRST TIME, READ THE FOLLOWING SECTION CAREFULLY.

The voltage of the available power supply differs according to country or region. Be sure that the power supply voltage of the area where the unit will be used meets the required voltage (e.g., AC120V, 60Hz or AC100-240V, 50/60Hz) written on the rear panel.

6. Do not touch the unit with wet hands

Do not handle the unit or power cord when your hands are wet or damp. If water or any other liquid enters the case, take the unit to an authorized service center for inspection.

7. Location of the unit

- Place the unit in a well-ventilated location.
Take special care to provide plenty of ventilation on all sides of the unit especially when it is placed in an audio rack. If ventilation is blocked, the unit may overheat and malfunction.
- Do not expose the unit to direct sunlight or heating units as the unit's internal temperature may rise and shorten the life of the pickup.
- Avoid damp and dusty places and places directly affected by vibrations from the speakers. In particular, avoid placing the unit on or above one of the speakers.
- Be sure the unit is placed in a horizontal position. Never place it on its side or on a slanted surface as it may malfunction.
- When you place the unit near a TV, radio, or VCR, the playback picture may become poor and the sound may be distorted. In this case, place the unit away from the TV, radio, or VCR.

8. Care

From time to time you should wipe the front and rear panels and the cabinet with a soft cloth. For heavier dirt, dampen a soft cloth in a weak solution of mild detergent and water, wring it out dry, and wipe off the dirt. Following this, dry immediately with a clean cloth. Do not use rough material, thinners, alcohol or other chemical solvents or cloths since these could damage the finish or remove the panel lettering.

9. Notes on Handling

- When shipping the unit, use the original shipping carton and packing materials. For maximum protection, repack the unit as it was originally packed at the factory.
- Do not use volatile liquids, such as insect spray, near the unit. Do not leave rubber or plastic products in contact with the unit for a long time. They will leave marks on the finish.
- The top and rear panels of the unit **may become warm after a long period of use. This is not a malfunction.**
- When the unit is not in use, be sure to remove the disc and turn off the power.
- If you do not use the unit for a long period, the unit may not function properly in the future. Turn on and use the unit occasionally.

10. To Obtain a Clear Picture

The unit is a high technology, precision device. If the optical pick-up lens and disc drive parts are dirty or worn down, the picture quality becomes poor. To obtain a clear picture, we recommend regular inspection and maintenance (cleaning or parts replacement) every 1,000 hours of use depending on the operating environment. For details, contact your nearest dealer.

11. Notes on Moisture Condensation

**Moisture condensation damages the unit.
Please read the following carefully.**

- **What is moisture condensation?**
Moisture condensation occurs, for example, when you pour a cold drink into a glass on a warm day. Drops of water form on the outside of the glass. In the same way, moisture may condense on the optical pick-up lens inside the unit, one of the most crucial internal parts of the unit.
- **Moisture condensation occurs in the following cases.**
 - When you bring the unit directly from a cold place to a warm place.
 - When you use the unit in a room where you just turned on the heater, or a place where the cold wind from the air conditioner directly hits the unit.
 - In summer, when you use the unit in a hot and humid place just after you move the unit from an air conditioned room.
 - When you use the unit in a humid place.
- **Do not use the unit when moisture condensation may occur.**
If you use the unit in such a situation, it may damage discs and internal parts. Remove the disc, connect the power cord of the unit to the wall outlet, turn on the unit, and leave it for two or three hours. After a few hours, the unit will have warmed up and evaporated any moisture. Keep the unit connected to the wall outlet and moisture condensation will seldom occur.

Table of Contents

Important Safeguards/Precautions/Table of Contents	2–5
--	-----

Getting Started

Features/Supplied Accessories	6
Preparing the Remote Controller	7
Connecting to a TV	8
Connecting to an Amplifier (To Enjoy the Sound Advantage of the DVD Player) ..	9
Connecting the Power/Turning on the DVD Player	10
Notes on Discs	11

Basic Playback

Playing DVD Videos/VIDEO CDs/Audio CDs	12
Locating a Specific Title/Chapter/Track/Location	16

Advanced Playback

Playing Repeatedly	19
Playing in a Favorite Order	20
Playing in Random Order	21
Zooming a Picture	22
Selecting the Camera Angle	23
Turning on/off Subtitles/Selecting the Subtitle Language	24
Selecting the Audio Language and Sound System as a set	25
Using Information on the On-Screen Display and the DVD Player's Display	26

Function Setup

Customizing the Function Settings	28
Table of Languages	36

Others

Troubleshooting	37
Specifications	38
Index to Parts and Controls	39

Features/Supplied Accessories

Features

- DTS*1/Dolby Digital*2/MPEG2/PCM Digital Audio Outputs
- Advanced 96-kHz/24-Bit D/A Converters
- Video CD Capability
- 27-MHz/10-bit Video D/A Conversion
- 3-Mode "Zoom-In" Function
- Audiophile-Grade Audio Performance
- RGB Video Output Scart Connector
- Composite Outputs
- High Resolution On-screen Display
- Full-Function Remote Control Supplied

*1 "DTS" and "DTS Digital Surround" are trademarks of Digital Theater Systems, Inc.
*2 Manufactured under license from Dolby Laboratories.
"Dolby", "Pro Logic" and the double-D symbol  are trademarks of Dolby Laboratories. Confidential Unpublished Works. ©1992-1997 Dolby Laboratories, Inc. All rights reserved.

Supplied Accessories

Make sure your box contains everything listed below.
If any pieces are missing, contact your nearest ONKYO dealer.
The number of accessories is indicated in brackets.

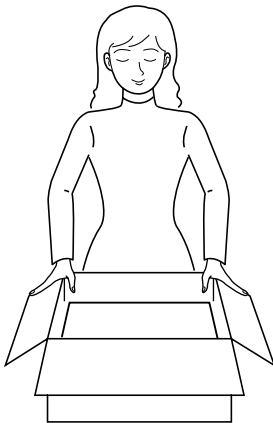

Remote controller (RC-419DV) [1]

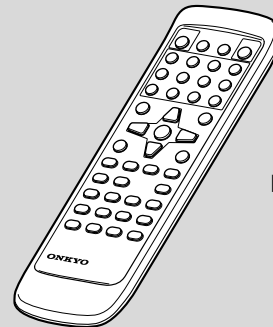

Batteries (size AA/UM-3) [2]

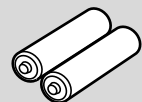

SCART cable [1]

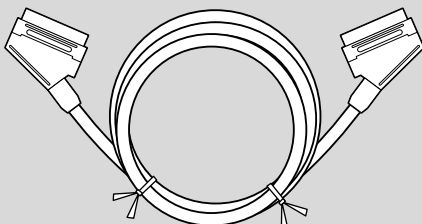

Audio/video connection cable [1]

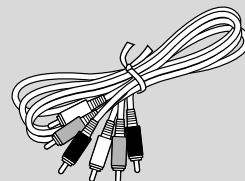

Preparing the Remote Controller

Inserting the Batteries

- 1 Open the battery compartment cover.

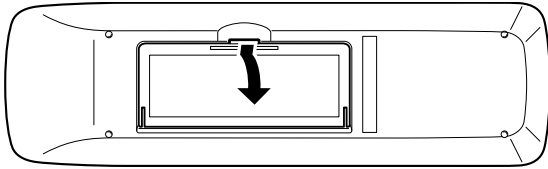

- 2 Insert the two R6 (size AA) batteries. Be sure to match the + and - ends of the batteries with the diagram inside the battery compartment.

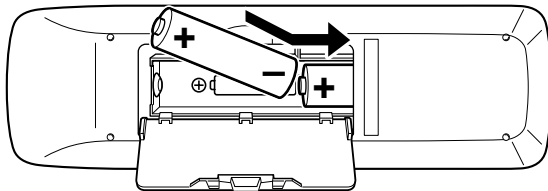

- 3 Close the battery compartment cover.

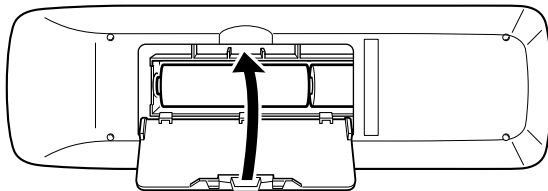

Notes

- Do not mix new batteries with old batteries or different kinds of batteries.
- To avoid corrosion, remove the batteries if the remote controller is not to be used for a long time.
- Remove dead batteries immediately to avoid damage from corrosion. If the remote controller does not operate smoothly, replace both batteries at the same time.
- The life of the batteries supplied is about six months but this will vary depending on usage.

Using the Remote Controller

Point the remote controller toward the remote control sensor.

STANDBY indicator
(as remote control reception indicator)
The STANDBY indicator lights up each time the DVD Player receives a signal from the remote controller. For the other functions of this indicator, see page 10.

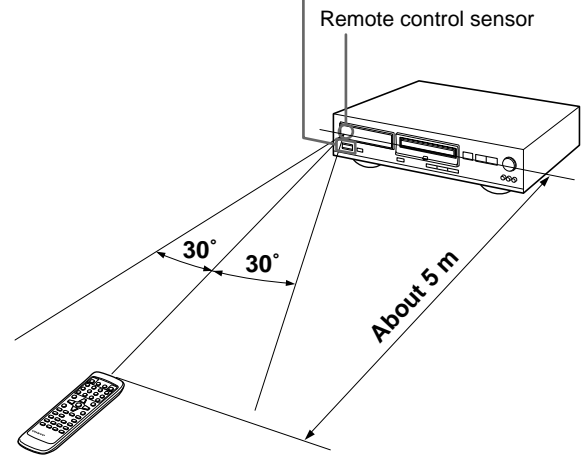
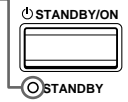

Notes

- Place the unit away from strong light such as direct sunlight or inverted fluorescent light which can prevent proper operation of the remote controller.
- Using another remote controller of the same type in the same room or using the unit near equipment which uses infrared rays may cause operational interference.
- Do not put any object such as a book on the remote controller. The buttons of the remote controller may be pressed by mistake and drain the batteries.
- Make sure the audio rack doors do not have colored glass. Placing the unit behind such doors may prevent proper remote controller operation.
- If there is any obstacle between the remote controller and the remote control sensor, the remote controller will not operate.

Connecting to a TV

Before connecting

- Refer also to the instruction manual of the TV.
- When you connect the DVD Player to the TV, be sure to turn off the power and unplug both units from the wall outlet before making any connections.
- Connect the DVD Player to the TV directly. If you connect the DVD Player to a VCR, TV/VCR combination, or video selector, the playback picture may be distorted as DVD videos are copy protected.

- Note that one audio/video connection cable and one S video connection cable are supplied. To use the audio/video cable for only the audio connection, leave the yellow plug disconnected.
- Connect the plugs securely.

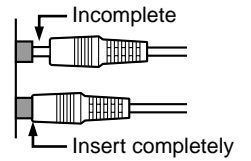

Connecting to a TV With Component Video Inputs

If the TV or monitor has component video inputs, make this connection. Connecting to these inputs allows you to enjoy higher quality picture playback compared to the connections explained in "Connecting to a TV Without Component Video Inputs" below.

Notes

- Actual labels for component video inputs may vary depending on the TV manufacturer (ex. Y/Cb/Cr, Y/B-Y/R-Y, etc.).
- In some TVs, the color levels of the playback picture may be reduced slightly or the tint may change. In such a case, adjust the TV for optimum performance.

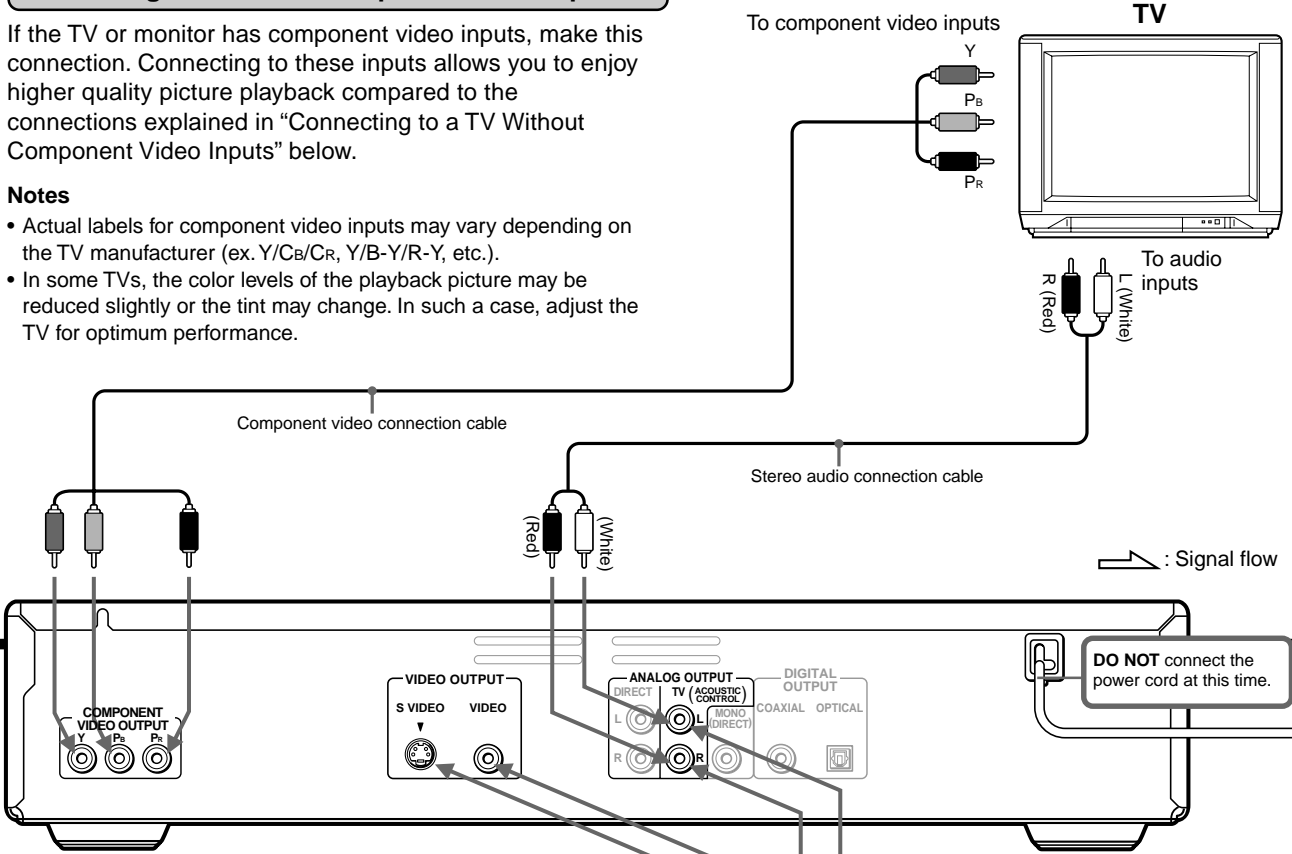

Connecting to a TV Without Component Video Inputs

If the TV or monitor has an S video input, make the S video connection. The S video connection will provide higher quality picture playback.

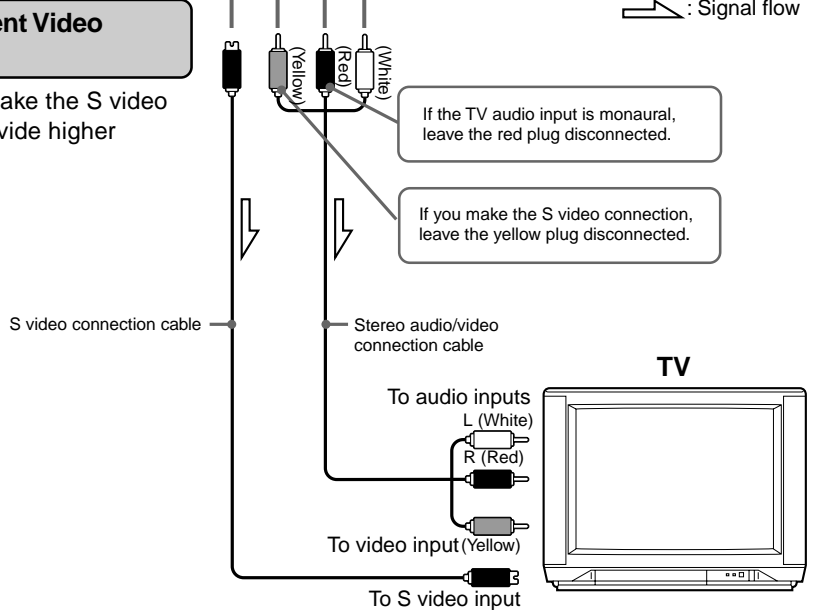

Connecting to an Amplifier (To Enjoy the Sound Advantage of the DVD Player)

Although you can reproduce the DVD Player's sound from the TV speakers with the connections on the opposite page, connecting with an amplifier and subwoofer provide you high quality dynamic sounds.

To reproduce Dolby Digital surround, MPEG1 audio, MPEG2 audio*, and DTS surround sound, you need to connect to an amplifier with a Dolby Digital, MPEG1 audio, MPEG2 audio*, and DTS decoder respectively.

Before connecting

- Refer to the instruction manual of the amplifier.
- When you connect the DVD Player to the amplifier, be sure to turn off the power and unplug both units from the wall outlet before making any connections. Otherwise, the speakers may be damaged.
- Note that one audio/video connection cable is supplied. To use this cable for the analog connection, leave the yellow plug disconnected.

- Connect the plugs securely.

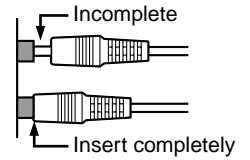

Making a digital connection with the amplifier

■ If the amplifier has a Dolby Digital/DTS/MPEG1/MPEG2*/Dolby Pro Logic decoder

After completing the steps on page 10, set "Audio Out Select" to "Bitstream" using the menu explained in "Customizing the Function Settings" starting from page 28. See page 32 for direct information.

Warning

DO NOT set "Audio Out Select" to "Bitstream" if the amplifier does not have any of the decoders described above. If you do so, high volume sound may be output and damage your hearing as well as the speakers.

■ If the amplifier doesn't have any of the above decoders (2 channel digital stereo type amplifier)

After completing the steps on page 10, set "Audio Out Select" to "PCM" using the menu explained in "Customizing the Function Settings" starting from page 28. See page 32 for direct information.

Note

- **DO NOT** set "Audio Out Select" to "Bitstream." See "Warning" above.
- If "Audio Out Select" is set to "Analog 2ch," PCM sounds may not be reproduced depending on the sound format.

An amplifier with a Dolby Digital/DTS/MPEG1/MPEG2* decoder or 2 channel digital stereo

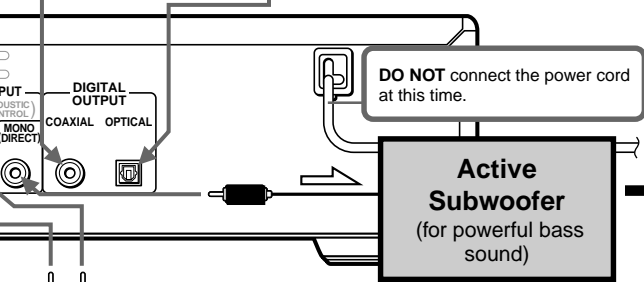
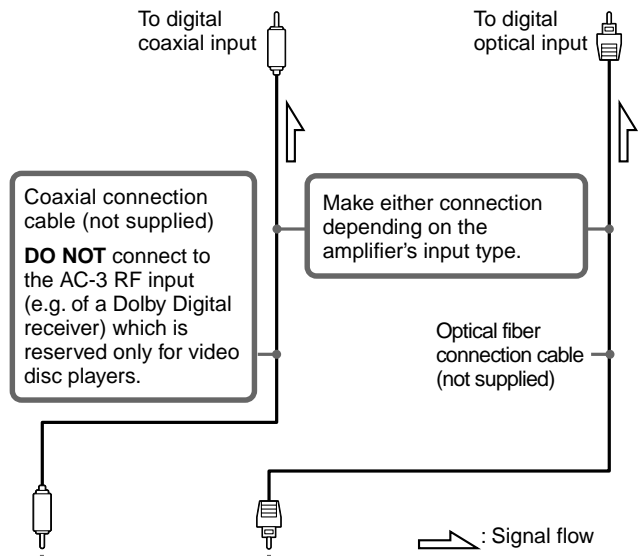

Making the analog connection with the amplifier

If your amplifier has no digital audio input, you can make the analog connection. If the amplifier has a Dolby Pro Logic decoder, you can reproduce the Dolby Pro Logic surround sound.

Note

Make sure that "Audio Out Select" is set to "Analog 2ch" (the factory setting) to reproduce the Dolby Pro Logic surround sounds with the analog connection. For details on the "Audio Out Select" setting, see page 32.

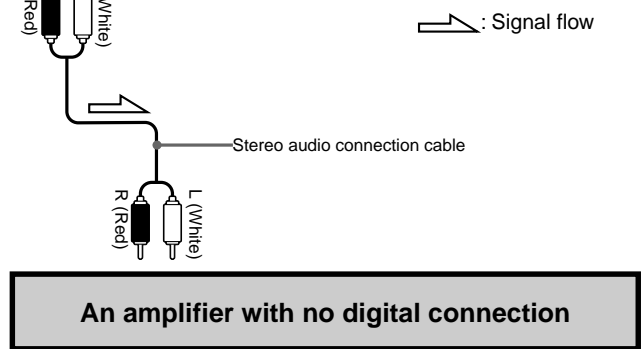

* Not applicable for USA and Canadian models

Connecting the Power/ Turning on the DVD Player

Before connecting

- Make sure that all the connections on pages 8 and 9 are complete (the connection to a TV is required).
- Turning on the DVD Player may cause a momentary power surge, which might interfere with other electrical equipment such as computers. To prevent the interference, use a wall outlet on a different circuit.

1 Connect the power cord to a wall outlet.

To a wall outlet

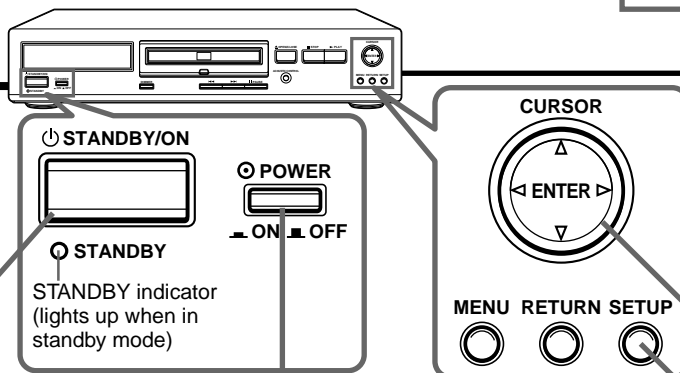
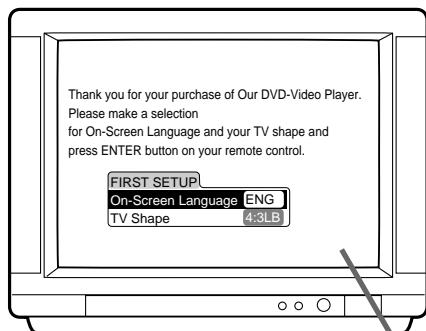

The remote controller can also be used to operate step 3.

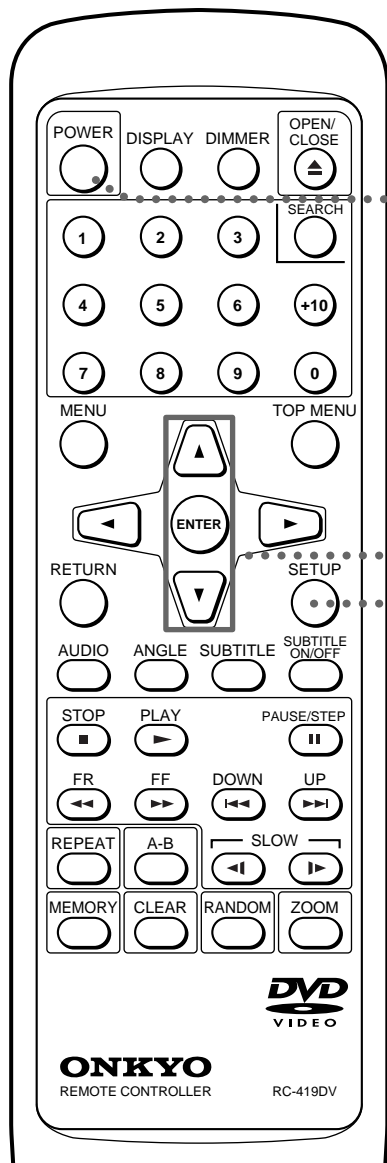

2 Press the POWER switch to switch on the main power.

The DVD Player enters standby mode.
The STANDBY indicator lights up.

Notes

- The buttons on the remote controller don't operate if the POWER switch is set to OFF.
- To switch off the main power, press the POWER switch again.

3 Press STANDBY/ON on the DVD Player or POWER on the remote controller.

The DVD Player turns on. The STANDBY indicator goes off.

The first time you turn on the DVD Player, the First Setup screen appears.

With the First Setup screen, select the On-Screen Language and TV Shape according to the aspect ratio of the TV screen (see pages 30 and 31) following the steps below.

- 1 Press ▲/▼ to select "On-Screen Language," then press ENTER (the center of the cursor).
- 2 Select a language with ▲/▼, then press ENTER.
- 3 Press ▼ to select "TV Shape," then press ENTER.
- 4 Press ▲/▼ to select the aspect ratio of the TV screen, then press ENTER.
- 5 Finally press SETUP.
All your selections are set and the First Setup screen disappears.

Notes



- To turn off the DVD Player, press STANDBY/ON on the DVD Player, or POWER on the remote controller. The DVD Player enters standby mode. Be sure to set the volume to minimum before turning off the DVD Player for the next use to avoid sudden loud sound reproduction.
- You can change the above settings later with "Customizing the Function Settings" on page 28.

Notes on Discs

This section shows you how to handle, clean, and store discs.

Playable Discs

This DVD Player can playback the following discs.

	Disc mark	Contents	Disc size	Maximum playback time
DVD videos		Audio + Video (moving pictures)	12 cm	Approx. 4 hours (single sided disc) Approx. 8 hours (double sided disc)
			8 cm	Approx. 80 minutes (single sided disc) Approx. 160 minutes (double sided disc)
			12 cm	Approx. 74 minutes
			8 cm	Approx. 20 minutes
VIDEO CDs		Audio + Video (moving pictures)	12 cm	Approx. 74 minutes
			8 cm	Approx. 20 minutes
Audio CDs		Audio	12 cm	Approx. 74 minutes
			8 cm (CD single)	Approx. 20 minutes

- You cannot playback discs other than those listed above.
- You cannot play discs such as CD-R, CD-RW, CD-ROM, DVD-RAM, DVD-RW, etc., even if the marks in the above table are labeled on those discs.
- This DVD Player uses the PAL*/NTSC color system, and cannot playback DVD videos recorded in any other color system (SECAM, etc.).
- Avoid using heart-shaped or octagonal discs. Playing irregularly shaped discs may damage the internal mechanism of the DVD Player.

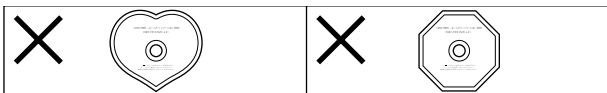

- Do not use discs that have residue from adhesive tape, rental discs that have peeling labels, or discs that have custom labels or stickers. Otherwise, you may not be able to eject the discs or the DVD Player may become inoperative.

* Not applicable for USA and Canadian models

Handling Discs

- Do not touch the playback side of the disc.

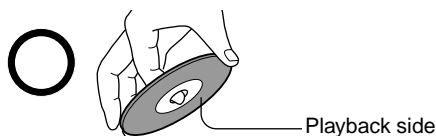

- Do not attach paper or tape to discs.



Cleaning Discs

- Fingerprints and dust on the disc cause picture and sound deterioration. Wipe the disc from the center outwards with a soft cloth. Always keep the disc clean.

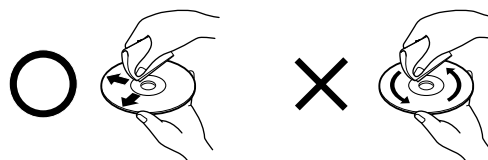

- If you cannot wipe off the dust with a soft cloth, wipe the disc lightly with a slightly moistened soft cloth and finish with a dry cloth.
- Do not use any type of solvent such as thinner, benzene, commercially available cleaners or antistatic spray for vinyl LPs. It may damage the disc.

Storing Discs

- Do not store discs in a place subject to direct sunlight or near heat sources.
- Do not store discs in places subject to moisture and dust such as a bathroom or near a humidifier.
- Store discs vertically in a case. Stacking or placing objects on discs outside of their case may cause warping.

About VIDEO CDs

This DVD Player supports VIDEO CDs equipped with the PBC (Version 2.0) function. (PBC is the abbreviation of Playback Control.) You can enjoy two playback variations depending on the type of disc.

- VIDEO CD not equipped with PBC function (Version 1.1)**
Sound and movies can be played on this DVD Player in the same way as an audio CD.
- VIDEO CD equipped with PBC function (Version 2.0)**
In addition to operation of the VIDEO CD not equipped with the PBC function, you can enjoy playback with interactive software and search function using the menu displayed on the TV screen (Menu Playback). Some of the functions described in this Instruction Manual may not work with some discs.

Notes on Copyright

It is forbidden by law to copy, broadcast, show, broadcast on cable, play in public, and rent copyrighted material without permission.

DVD videos are copy protected, and any recordings made from these discs will be distorted.

This product incorporates copyright protection technology that is protected by method claims of certain U.S. patents and other intellectual property rights owned by Macrovision Corporation and other rights owners. Use of this copyright protection technology must be authorized by Macrovision Corporation, and is intended for home and other limited viewing uses only unless otherwise authorized by Macrovision Corporation. Reverse engineering or disassembly is prohibited.

Playing DVD Videos / VIDEO CDs / Audio CDs

Before playing

- DVD Videos, VIDEO CDs, and audio CDs can be played with the DVD Player (see "Playable Discs" on page 11). Do not play anything else.
- When playing DVD videos or VIDEO CDs, turn on the TV and set the TV to the DVD Player's input.
- If the audio system is connected to the DVD Player, turn on the audio system and set it to the DVD Player's input.

About the , , and marks in the pages related to disc operation

 means "The function or title is related to DVD operation."



 means "The function or title is related to VIDEO CD operation."

 means "The function or title is related to audio CD operation."

Warning

If the DVD Player is connected to the TV or amplifier through the analog audio jacks, do not play DTS-encoded discs. Excessive noise may be output from the analog stereo jacks, which may damage the connected equipment.

To reproduce DTS surround sounds, digital connection to an amplifier with a DTS decoder is needed.

Basic Playback

1 Press .

The disc tray opens.

If the DVD Player is in standby mode when the button is pressed

The DVD Player turns on and the disc tray opens. In this case, it takes several seconds until the disc tray opens.

2 Place the disc on the disc tray.

Put the disc in the tray with the label side facing up.

There are two different disc sizes. Place the disc in the correct guide on the disc tray.

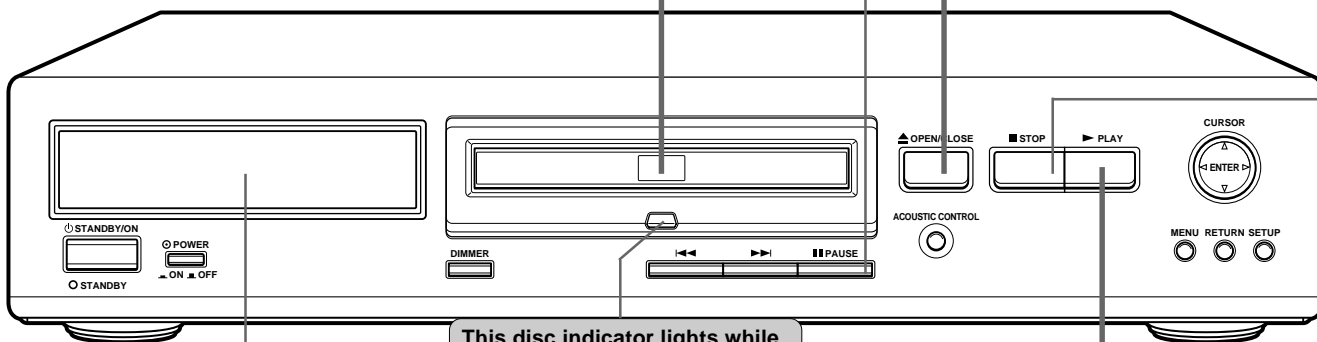
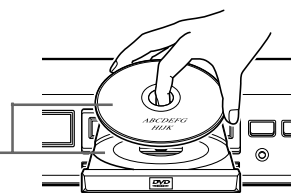

3 Press .

The disc tray closes and playback starts. If you press  to close the tray after step 2, playback may automatically start depending on the disc.





The type of the inserted disc lights. For the other information that appears in the display, see pages 26 and 27.

 If any menu appears on the TV screen

 See "Operating the menu appearing on the TV screen" on page 15.

 If the sound is not reproduced

 • See "Warning" above.

 • Recheck the connections and settings on pages 8 and 9.

 • See "Tips to select the most suitable audio format" on page 15.

CAUTION

Keep your fingers well clear of the disc tray as it is closing. Neglecting to do so may cause serious personal injury.

DVD **If the screen on the right appears – Screen Saver**
If you pause a picture for a long time, the screen saver operates.

To resume normal display, press ►.

(You can set this function to Off using the menu explained in “Customizing the Function Settings” starting from page 28. See page 33 for direct information.)



DVD **Tip to obtain a higher quality picture**

Occasionally, some picture noise not usually visible during a normal broadcast may appear on the TV screen while playing a DVD video because the high resolution pictures on these discs include a lot of information. While the amount of noise depends on the TV you use, you should generally adjust the TV to reduce sharpness when viewing DVD videos.

DVD **To play NTSC discs (Multisystem TV is needed)***

Set “PAL/Auto” to “Auto” using the menu explained in “Customizing the Function Settings” starting from page 28. See page 31 for direct information.

* Not applicable for USA and Canadian models

■ To remove the disc

DVD VCD CD

Press ▲ to open the disc tray.

Remove the disc after the disc tray opens completely. After removing the disc, be sure to press the button again to close the tray.

■ To pause playback (still mode)

DVD VCD CD

Press || during playback.

To start playback, press ►.

DVD **To play frame by frame**

VCD Press the button repeatedly during pause. Each time you press the button the picture advances one frame. To resume normal playback, press ►.

Note

The sound is muted during still mode and frame by frame playback.

■ To stop playback

DVD VCD CD

Press ■.

When you press ► to restart playback, playback starts from the location where you stopped playback because the location index is stored in memory.

Note

The location where playback resumes may vary depending on the disc or the scene where you stopped.

Resuming playback from the beginning

Press ■ again after stopping playback to clear the location index memory, then press ► to start playback.

DVD Playback starts from the beginning of the current title. To start playback from the beginning of the DVD video, open and close the disc tray (press ▲ twice) then press ► to start playback.

VCD Playback starts from the beginning of the disc.

CD

Note

The location index memory will also be cleared when:

- The power cord is unplugged,
- The DVD Player has entered standby mode,
- The disc tray is opened, and
- The parental lock setting is changed (see page 34) or a disc menu language is selected (see page 30).

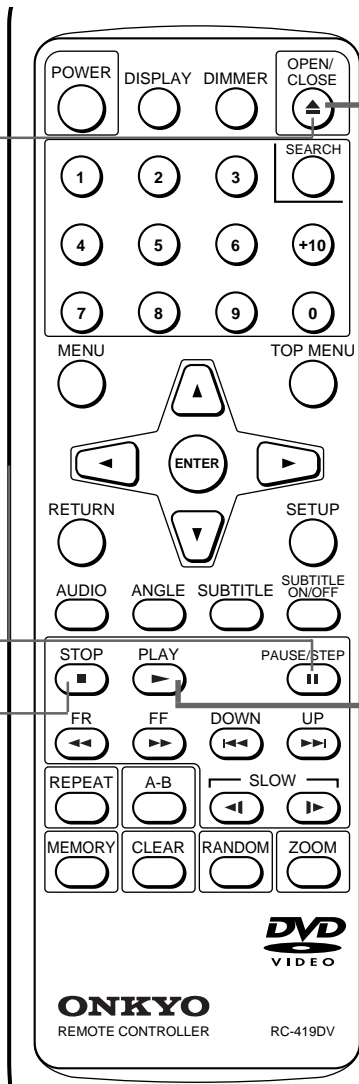

Notes

- Do not move the DVD Player during playback. Doing so may damage the disc.
- Use the ▲ button on the remote controller or DVD Player to open and close the disc tray. Do not touch the disc tray while it is moving. Doing so may cause the DVD Player to malfunction.
- Do not press down on the disc tray or put any objects other than playable discs on the disc tray. Doing so may cause the DVD Player to malfunction.
- In many instances, a menu screen appears when playback of a movie is complete. Prolonged display of an on-screen menu may damage your television set, permanently etching that image onto its screen. To avoid this, be sure to press ■ once the movie is complete.

Playing DVD Videos / VIDEO CDs / Audio CDs

■ To play in fast reverse or fast forward

DVD VCD CD

Press ◀◀ (Fast Reverse) or ▶▶ (Fast Forward) during playback.

DVD The playback speed becomes two times the normal speed. Each press of the same button changes the playback speed as follows:

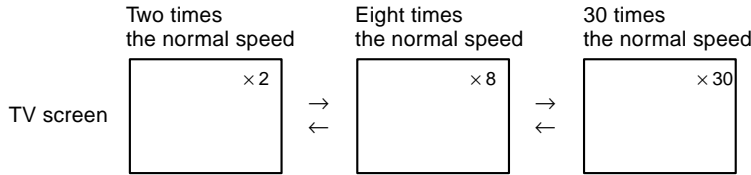

Notes

- No sound is reproduced and no subtitles appear during fast forward or reverse playback.
- The ×2, ×8, and ×30 speeds are only approximate speeds. These speeds may vary slightly from disc to disc.

VCD Each time you press the same button, the playback speed alternates with the other as follows:

CD To check the marks on the right while playing a CD, turn on the TV and set the TV to the DVD Player's input.

Note

No sound is reproduced and no subtitles appear while playing back a VIDEO CD, whereas the sound is reproduced while playing back an audio CD.

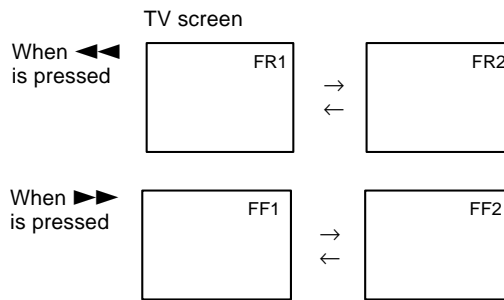

To resume normal playback, press ▶.

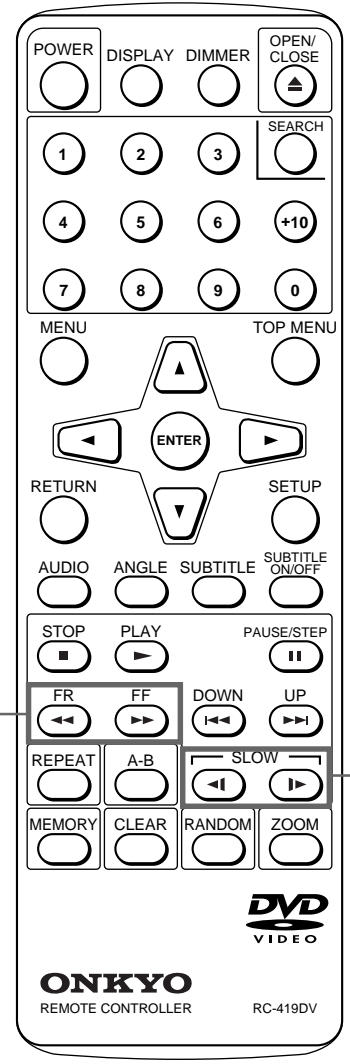

■ To play in slow-motion

DVD VCD

Press ◀| (reverse slow-motion)* or |▶ (forward slow-motion) during playback.

Each press of the same button changes the slow-motion speed as follows:

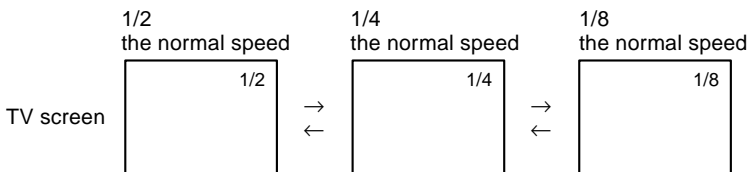

Note

The sound is muted during slow-motion playback.

To resume normal playback, press ▶.

* This button operates only for DVD discs.

Enjoying powerful bass sound

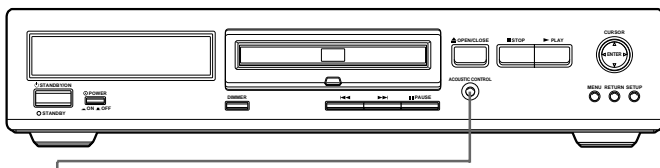

ACUSTIC CONTROL button/indicator

Each press of the button changes the mode as follows:
Bass Cut (Lit in green) → Bass Boost (Lit in orange)

↙ ↘
Off (Not lit)

■ When using the TV speakers

The audio connection on page 8 is required.

To boost bass sound, select the Bass Boost mode as shown on the left.

■ When using an active subwoofer

Connecting an active subwoofer as shown on page 9 provides better bass sound than boosting bass sound from the TV speakers. When reproducing the sound from the subwoofer, select the Bass Cut mode as shown on the left.

Operating the menu appearing on the TV screen

About disc menu

A DVD video may include more than one language and more than one sound system. In many instances, such DVD videos let you choose the language (e.g. disc menu language/audio language/subtitle language), sound system, and so on using the menu.

Depending on the disc, the name of the disc menu varies and the disc menu may be included in the main menu.

About title menu

A DVD video or VIDEO CD with the PBC (Playback Control) function (see "About VIDEO CDs" on page 11) may let you locate a title/chapter (see page 16) using the menu.

Depending on the disc, the name of the title menu varies and the title menu may be included in the main menu.

If any menu appears on the TV screen, press ▲/▼/◀/▶ to select the item or setting, then press ENTER to confirm.

The operation varies depending on the disc. Follow the disc instructions.

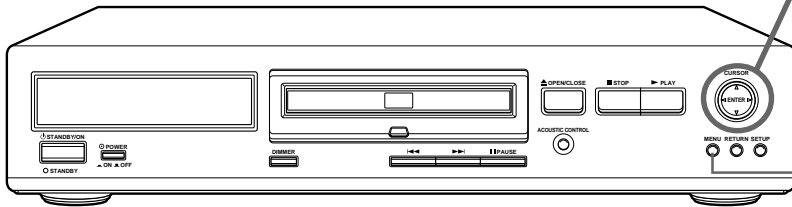

▲/▼/◀/▶/ENTER

Remote controller operation

Press the appropriate button.

DVD Player operation

Press the appropriate mark on CURSOR.

To confirm, press the center of CURSOR (ENTER).

To display the disc menu again
Press MENU.

To display the title menu again
Press TOP MENU.

If the button doesn't work
Try the other one. Some discs do not include a menu.

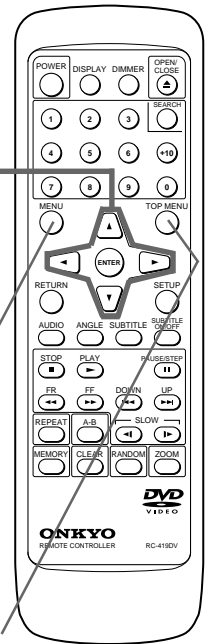



Tips to select the most suitable audio format

If a DVD video includes more than one sound system, you may need to select the sound system with the above explained disc menu.

The following are tips on how to select the most suitable sound system. See also pages 8 and 9 and the amplifier's manual.

When you make the digital connection to the amplifier

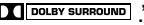
- Does the amplifier have a DTS decoder?
→ Select "DTS" or .
- Does the amplifier have a Dolby Digital decoder?
→ Select "Dolby Digital," "6CH," "5.1CH," or .
- Does the amplifier have an MPEG2 decoder*?
→ Select "MPEG2" or  "Multichannel."
- Is the DVD Player connected to an amplifier with a Dolby Pro Logic Surround decoder?
→ Select "Dolby Pro Logic surround" or .
- Is the amplifier a 2 channel stereo type?
→ Select "Stereo."

When you make the analog connection to the amplifier/ When you reproduce the sound from the TV speakers

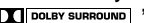
- Is the DVD Player connected to an amplifier with a Dolby Pro Logic Surround decoder?
→ Select "Dolby Pro Logic surround" or .
- Is the amplifier a 2 channel stereo type?
→ Select "Stereo."
- Do you reproduce the sound only from the TV speakers?
→ Select "Stereo."

Notes

- Dolby Digital, PCM, MPEG2* sounds are converted to analog and can be reproduced as stereo sounds.
- DTS sounds are not reproduced with the analog connection.

Various sound formats and sound effects

Minimum speaker configuration for DTS/Dolby Digital/MPEG2* surround sounds

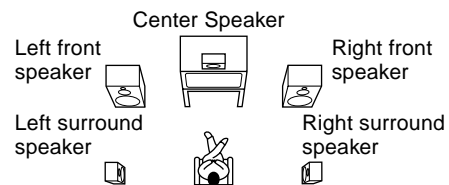

The 5.1-channel digital surround format of DOLBY DIGITAL/DTS/MPEG2* enables you to individually play five full-range (20Hz-20kHz) channels (left and right front, center, two surround channels) plus an LFE (Low Frequency Effect) channel for the low-range effect sound. It will create a realistic sound as heard in theaters and concert halls.

DOLBY DIGITAL Surround

DVD videos that have the  mark are recorded using this system.

DTS Surround

DVD videos and audio CDs that have the  mark are recorded using this system.

MPEG2*

DVD videos that have the  "Multichannel" mark are recorded using this system. MPEG2 may have 8 channels. In this case, left and right center speakers in addition to the above speaker configuration are used.

DOLBY PRO LOGIC Surround

This surround format consists of 4 channels (left and right front, center, and monaural surround channel) and emphasizes the center channel. This format is very effective for panning music, conversation, and three-dimensional sound movement output from three front channels. It also simulates the atmosphere and surround effects of the sound reflected from the side and rear walls of the theater.

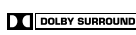
DVD videos that have the  mark are recorded using this system.

* Not applicable for USA and Canadian models

Locating a Specific Title / Chapter / Track / Location

The structure of the disc content

DVD video

Normally, DVD videos are divided into titles, and the titles are subdivided into chapters.

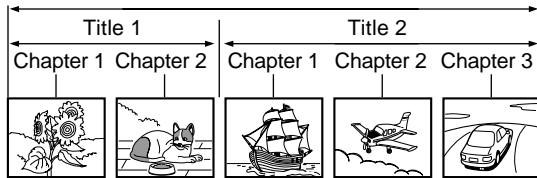

VIDEO CD/Audio CD

VIDEO CDs and Audio CDs are divided into tracks.

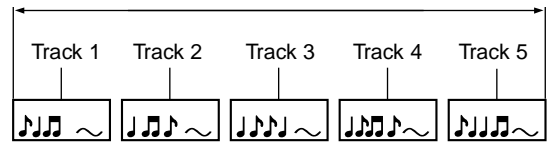

Locating a title using the title menu

If a DVD video contains a title menu, you can locate a specific title using the title menu function.



Press TOP MENU. (Depending on the DVD video, press MENU.)

The title menu appears on the TV screen.

Example of a title menu.

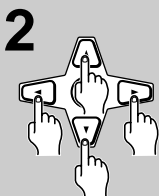
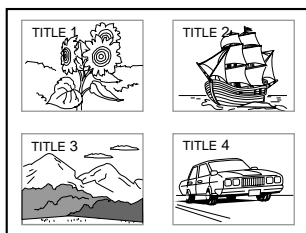

Press ▲/▼/◀/▶ to select the title you want.

If the titles in the title menu are assigned a number, you can also directly locate a specific title using the number buttons.

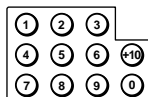

Press ENTER.

The DVD Player starts playback from chapter 1 of the selected title.

Notes

- The instructions above describe basic procedures which may vary depending on the contents of the DVD video. If different instructions appear on the TV screen, follow those instructions.
- If you display the title menu during playback and press TOP MENU again without selecting any title, the DVD Player usually resumes playback from the point where you first pressed TOP MENU. (There may be exceptional cases depending on the disc.)
- This method of locating a title is available only on a disc that contains a title menu.
- The name of the button in the instruction notes of discs varies depending on the disc.



Locating a specific title and chapter by entering the numbers

If a DVD video contains the numbers corresponding to the titles and chapters, you can locate a specific chapter in a specific title directly by entering the numbers.



Press SEARCH.

Make sure that the number next to "Title:" is highlighted. (You can shift the highlight using ▲/▼.)

e.g.

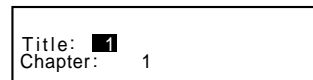

Press the number button(s) to enter the title number for the desired title.

e.g. To select title 2

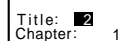

To select title 12

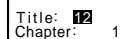
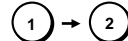

If you do not need to change the chapter number appearing below the title number, skip steps 3 and 4, and go to step 5.

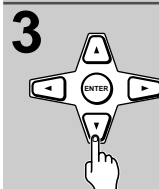

Press ▼ to highlight the number next to "Chapter:."

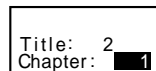

Press the number button(s) to enter the chapter number for the desired chapter.

e.g. To select chapter 25

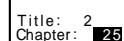
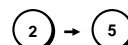

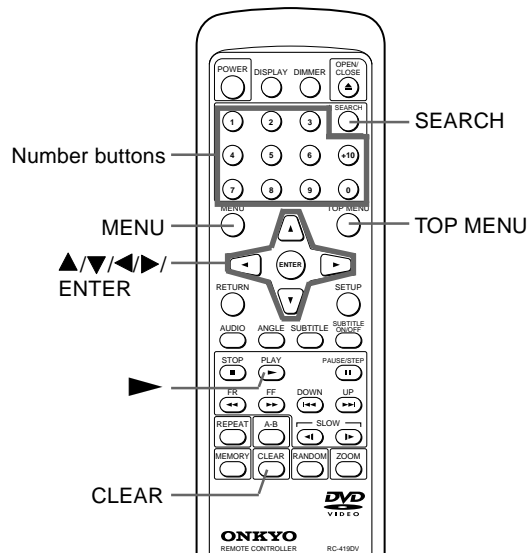

5 Press ►.

The DVD Player starts playback from the selected chapter in the selected title.

Notes

- To enter a number between 10 and 99, you can also use **+10** (plus ten button) as follows:



- This location method is available only on a disc that contains the numbers corresponding to the titles and chapters.
- To cancel the entered title and chapter numbers, press **CLEAR** before pressing ►. The title and chapter numbers in step 1 will be displayed.
- To close the Title/Chapter display, press **SEARCH** several times (the number of times you press **SEARCH** varies depending on the disc).

VCD CD

Locating a specific track directly

You can locate the desired track by entering the number.

1

Press the number button(s) to enter the track number for the desired track.

e.g. To select track 25

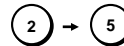
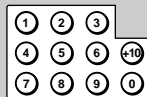

2



Press ►.

The DVD Player starts playback from the selected track.

Notes

- To enter a number between 10 and 99, you can also use **+10** (plus ten button) as follows:

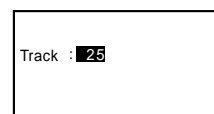

- To cancel the entered track number, press **CLEAR** before pressing ►. The current track number will be displayed.

Locating a Specific Title / Chapter / Track / Location

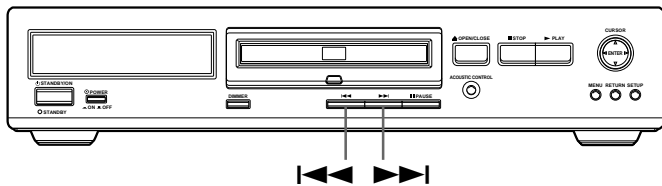

DVD VCD CD

Locating a specific chapter or track consecutively

You can locate consecutive chapters or tracks.

<p>Remote controller</p>	<p>Press I◀◀ or ▶▶I (repeatedly) to select the chapter or track you wish to start playing</p> <p>Press I◀◀ once to start playback from the beginning of the current chapter or track.</p> <p>Press I◀◀ repeatedly to select the former chapters or tracks in reverse order.</p> <p>Press ▶▶I repeatedly to select the next chapter or track in order.</p>
<p>DVD Player</p>	

Notes

- Some titles may not display chapter numbers.
- When you set "Title Stop" to "Off" (see page 35), you can locate consecutive chapters in another title. If you go back to the preceding title by pressing I◀◀, the DVD Player locates the first chapter of the title. When "Title Stop" is set to "On," you can locate consecutive chapters only within the current title.
- If you select the chapter or track during pause (while in still mode), you need to press ▶ to start playback.

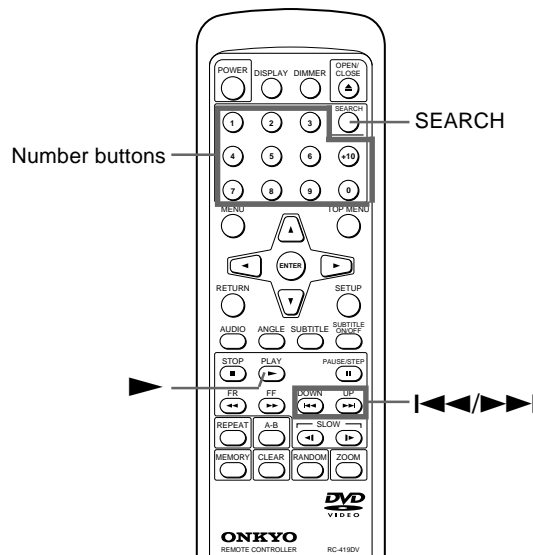

DVD VCD CD

Locating a specific location by entering the time

You can locate a specific location by entering its corresponding time (hours, minutes, and seconds).

<p>1</p>	<p>Press SEARCH twice.</p> <p>You may need to press the button more than twice (depending on the disc) until the following display appears.</p> <div style="border: 1px solid black; padding: 5px; width: fit-content; margin: 10px auto;"> Time : : : : </div>
<p>2</p> <p>e.g. 1 → 2 → 5 → 3 → 0</p> <p style="text-align: center;">Hours Minutes Seconds</p> <div style="border: 1px solid black; padding: 5px; width: fit-content; margin: 10px auto;"> Time 1:25:30 </div>	<p>Press the number buttons to enter the location's time.</p>
<p>3</p>	<p>Press ▶.</p> <p>The DVD Player starts playback from the entered location.</p>

Notes

- You can also use +10 (plus ten button) to add ten to the hours, minutes, or seconds.
- Some discs may not respond to this procedure.
- Some scenes may not be located precisely.
- This method for accessing specific locations is available only within the current title of the DVD video or within the current track of the VIDEO CD/audio CD.

Playing Repeatedly

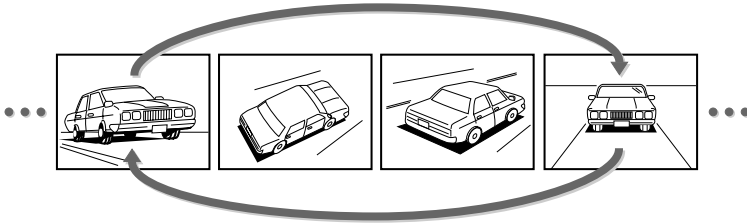

You can play a specific title, chapter, track, or segment repeatedly (Title repeat, chapter/track repeat, A-B repeat).

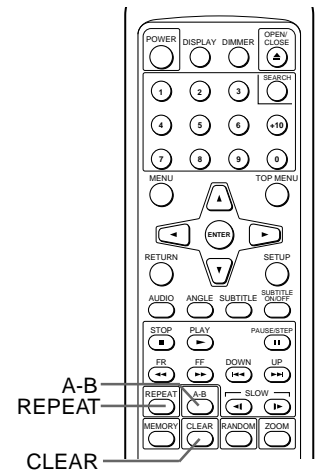

DVD VCD CD

Repeating a Title, Chapter, or Track



You can play the same title, chapter, or track repeatedly (Title, chapter/track repeat).

DVD VCD CD

Repeating a Specific Segment

You can play a specific segment repeatedly (A-B repeat).

1	Select the title, chapter, or track you want to repeat. (See pages 16 to 18.)												
2 	<p>Press REPEAT.</p> <p>Each time you press REPEAT, the repeat mode changes as follows.</p> <p>DVD</p> <table border="1"> <tr> <td>Chapter Repeat</td> <td>Repeats the same chapter.</td> </tr> <tr> <td>Title Repeat</td> <td>Repeats the same title.</td> </tr> <tr> <td>Repeat Off</td> <td>Resumes normal playback.</td> </tr> </table> <p>VCD CD</p> <table border="1"> <tr> <td>Track Repeat</td> <td>Repeats the same track.</td> </tr> <tr> <td>All Repeat</td> <td>Repeats the entire disc.</td> </tr> <tr> <td>Repeat Off</td> <td>Resumes normal playback.</td> </tr> </table>	Chapter Repeat	Repeats the same chapter.	Title Repeat	Repeats the same title.	Repeat Off	Resumes normal playback.	Track Repeat	Repeats the same track.	All Repeat	Repeats the entire disc.	Repeat Off	Resumes normal playback.
Chapter Repeat	Repeats the same chapter.												
Title Repeat	Repeats the same title.												
Repeat Off	Resumes normal playback.												
Track Repeat	Repeats the same track.												
All Repeat	Repeats the entire disc.												
Repeat Off	Resumes normal playback.												

1 	<p>Press A-B at the beginning of the segment (point A) you want to play repeatedly.</p> <div style="border: 1px solid black; padding: 5px; width: fit-content;">A-</div>
2 	<p>Press A-B again at the end of the segment (point B).</p> <div style="border: 1px solid black; padding: 5px; width: fit-content;">A-B</div> <p>The DVD Player automatically returns to point A and starts repeat playback of the selected segment (A-B).</p>

■ To resume normal playback

 **Press CLEAR.**

Notes

- Some discs may not permit A-B repeat operation.
- You can play a specific segment only within the current title or track.
- You cannot set the A-B repeat function for segments that include multiple camera angles.
- There may be a slight difference between point A and the location where playback actually resumes depending on the disc.

■ To resume normal playback

 **Press CLEAR.**

Note

Some discs may not permit repeat operation.

Playing in a Favorite Order

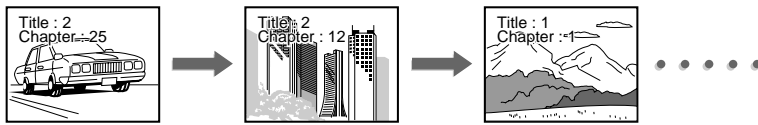

You can combine your favorite titles, chapters, or tracks and play them in any order. You can program up to 28 selections into the memory (Memory playback).

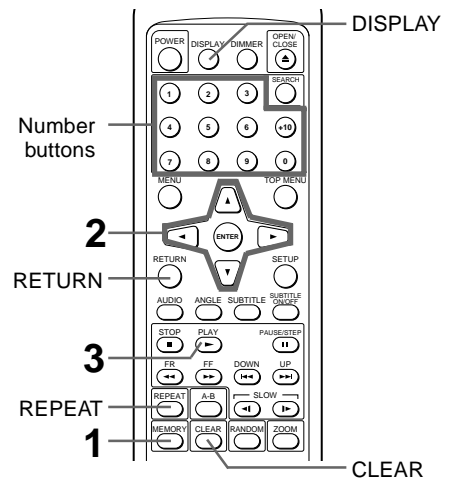

DVD VCD CD

Setting Titles, Chapters, or Tracks in a Favorite Order

The DVD Player automatically plays titles, chapters, or tracks in the order you program.

1 MEMORY

Insert a disc and press MEMORY while the disc is stopped.

The following display appears.

MEMORY					
T	C	T	C	T	C
1	---	8	---	15	---
2	---	9	---	16	---
3	---	10	---	17	---
4	---	11	---	18	---
5	---	12	---	19	---
6	---	13	---	20	---
7	---	14	---	21	---
				22	---
				23	---
				24	---
				25	---
				26	---
				27	---
				28	---

DVD T: Title number C: Chapter number
 VCD CD T: Track number C: Ignored even if a number is entered.

VCD CD

Press the number button(s) to select the track number, then press ENTER to confirm.

Repeat this step to select the next track.

3 PLAY

While the MEMORY display is displayed, press ►.

The DVD Player starts memory playback.

2

1 Press the number button(s) to enter the title number.

2 Press ► to highlight "--" below C.

3 Press the number button(s) to enter the chapter number.

4 Press ENTER to confirm.

To select another chapter in the same title
 Press the number button(s) for another chapter.

To select another title
 Press ◀ to highlight the next "--" below T, then repeat the above steps.

e.g. To play chapter 25 in title 2, chapter 12 in title 2, all the chapters in title 1, and chapter 2 in title 4.

Title number Chapter number

Memory 1: 2 → ► → 2 → 5 → ENTER

Memory 2: 1 → 2 → ENTER

Memory 3: ◀ → 1 → ENTER

Memory 4: 4 → ► → 2 → ENTER

MEMORY					
T	C	T	C	T	C
1	02	25	8	---	15
2	02	12	9	---	16
3	01	---	10	---	17
4	04	02	11	---	18
5	---	---	12	---	19
6	---	---	13	---	20
7	---	---	14	---	21
				22	---
				23	---
				24	---
				25	---
				26	---
				27	---
				28	---

■ To change or cancel the entered program

While the MEMORY display is displayed, press ▲/▼ to highlight the item. To select another title/chapter or track follow step 2. To cancel, press CLEAR.

■ To resume normal playback

Press CLEAR.

■ To program during playback

If you press MEMORY during playback, the display to accept your programming appears. To display the MEMORY display, press DISPLAY, then follow steps 2 and 3.

Notes

- You can also use +10 (plus ten button) to add ten to the number.
- Some discs may not permit memory playback operation.
- If you press REPEAT during memory playback, the DVD Player repeats the current memory playback.
- Although you can select title, chapter, and track numbers not included on the disc, those numbers are ignored.
- If you press MEMORY or RETURN while the MEMORY display is displayed, the MEMORY display disappears.
- The programmed selections will be cleared when you turn off the DVD Player.

Playing in Random Order

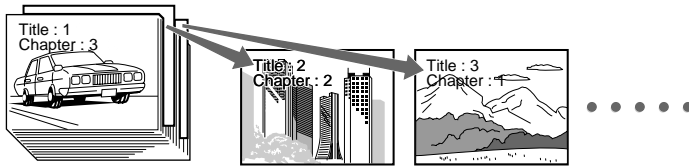

You can play titles, chapters within a title, or tracks in random order (Random playback).

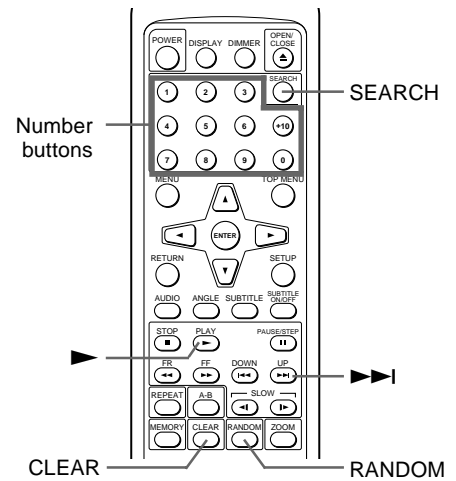

DVD VCD CD

Playing Titles or Tracks in Random Order

The DVD Player automatically selects the titles in a DVD video, or tracks in a VIDEO CD/audio CD, and plays them randomly.

DVD

Playing Chapters in Random Order

The DVD Player automatically selects the chapters in a title and plays them randomly.

1 **RANDOM**

Press RANDOM twice while the disc is stopped.
Then, press RANDOM repeatedly to change the random play mode as follows:
Chapter Random → Title Random

↙ Random off ↘

Title Random

2 **RANDOM**

Press RANDOM once while the disc is stopped.
Then, press RANDOM repeatedly to alternate the mode as follows:
Track Random ↔ Random off

Track Random
Track : ■

If you press RANDOM during playback, the DVD Player automatically starts random playback after finishing the current title or track.

2 **PLAY**

Within 5 seconds, press ►.
The DVD Player starts random playback.

1 **SEARCH**

Press SEARCH, then press the appropriate number button(s) for the title which contains the chapters you want to play in random order.

e.g. To play the chapters in title 2 in random order

SEARCH → 2

Title : ■2
Chapter: 1

2 **RANDOM**

Press RANDOM while the disc is stopped.

Chapter Random
Title : ■2
Chapter: 1

If you press RANDOM during playback, the DVD Player automatically starts random playback after finishing the current chapter.

3 **PLAY**

Within 5 seconds, press ►.
The DVD Player starts random playback.

■ To resume normal playback



Notes

- Some discs may not permit random playback operation.
- You cannot use the random playback function together with the memory playback function.
- If you press ►►I during random playback, the DVD Player goes to another title or track and continues random playback.

■ To resume normal playback



Notes

- You can also use +10 (plus ten button) to add ten to the number.
- Some discs may not permit random playback operation.
- You cannot use the random playback function together with the memory playback function.
- If you press ►►I during random playback, the DVD Player goes to another chapter and continues random playback.

Zooming a Picture

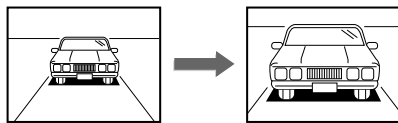

You can magnify areas within a picture.

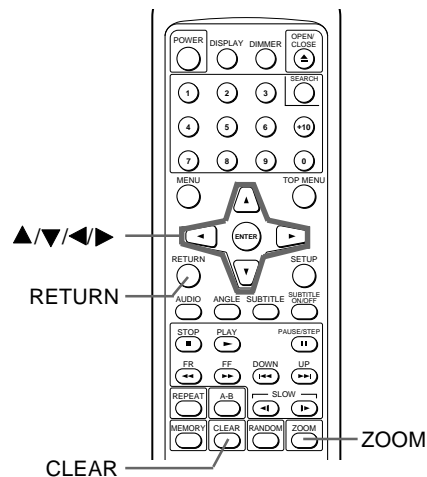

DVD

Zooming a Picture and Shifting the Zoom Point

You can zoom in on a picture. You can also shift the zoom point.



ZOOM

Press ZOOM during normal, slow, or still playback.

If you press ZOOM repeatedly, the magnification level increases.

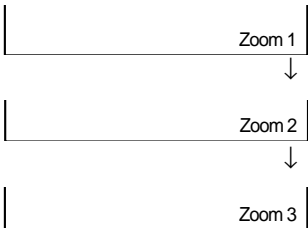



RETURN

To reduce the magnification level
Press RETURN.

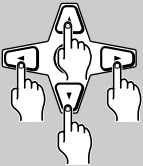

To shift the zoom point
Press ▲/▼/◀/▶.

When the zoom point reaches an edge of the picture, the color of "Zoom" changes.



CLEAR

To restore the original zoom point (center of the picture)
Press CLEAR.

■ To resume normal playback



Press ZOOM repeatedly until "Zoom" disappears.

Notes

- Some discs may not permit zoom operation.
- During some scenes, the buttons may not work as described above.
- Zooming does not work on subtitles or menu screens included on DVD videos.
- During zoom playback, ▲/▼/◀/▶ does not work on menu screens included on DVD videos. If you want to view the menus, cancel zoom playback.
- The magnification level varies depending on the picture size you select. (See pages 28 and 31.)

Selecting the Camera Angle

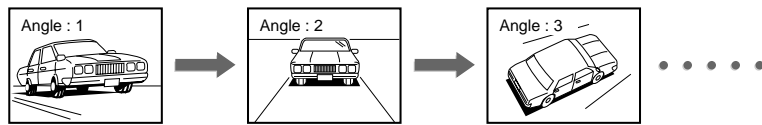

You can select a preferred camera angle to watch a scene.

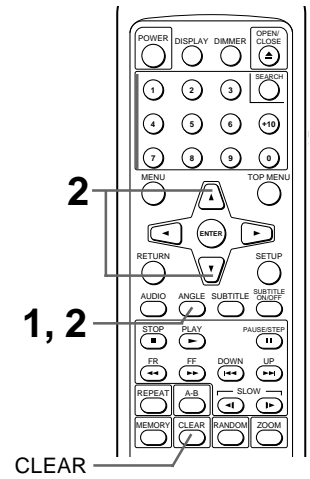

DVD

Changing the Camera Angle

If the scene was recorded from multiple angles, you can easily change the camera angle of the scene you are watching.



Press ANGLE while playing a scene recorded with multiple angles.

While playing a scene recorded with multiple angles, the angle icon (⊞) appears in the DVD display and on the TV screen. Press ANGLE while the angle icon is displayed.

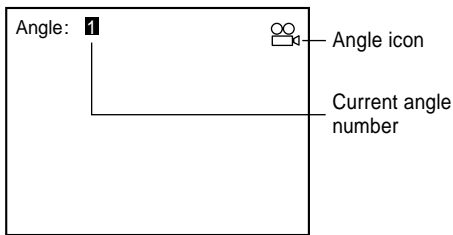

To turn off the angle number display



Press CLEAR.

To disable the angle icon display on the TV

Set "On-Screen Displays" to "Off" using the setting menu (see pages 28 and 33). Monitor the DVD display to check that the scene has multiple angles. The angle indicator (⊞) flashes in the DVD Player's display.

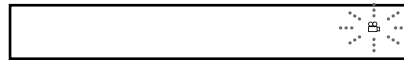

Notes

- You can change the camera angle during still playback. The camera angle changes to the new setting when you resume normal playback.
- If you pause a picture immediately after changing the camera angle, the resumed playback picture may not use the new camera angle.



Press ANGLE or ▲ while the angle number is displayed on the TV screen.

Each time you press ANGLE or ▲, the camera angle changes.

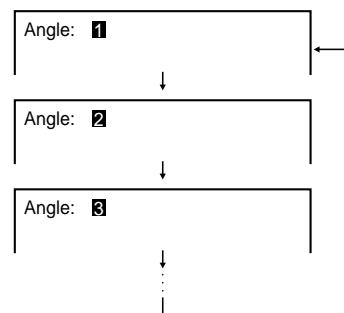

▼ : Cycles backwards

You can also change the camera angle directly by pressing the number buttons corresponding to the angle number.

Turning on/off Subtitles

Selecting the Subtitle Language



You can display subtitles on the TV screen and select a subtitle language from those included on the DVD video.

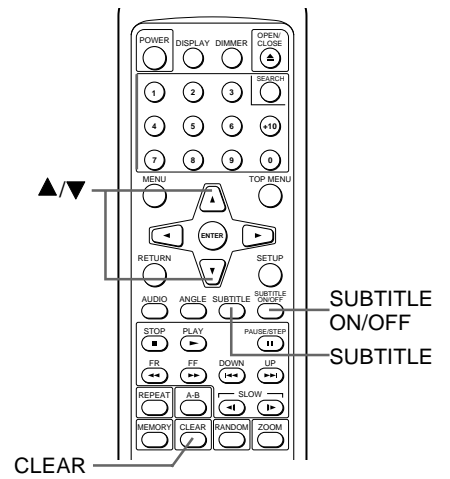

DVD

Turning subtitles on/off



Press SUBTITLE ON/OFF during playback.
Each press of the button turns subtitles on or off.
(The current subtitle setting is displayed for about 3 seconds.)

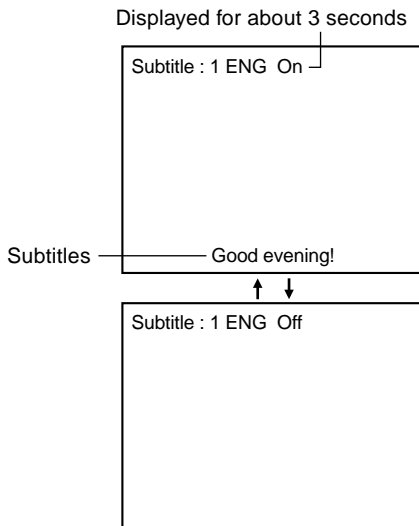

Notes

- Some DVD videos are set to display subtitles automatically, and you cannot turn them off even if you set the subtitle function to off.
- During some scenes, the subtitles may not appear immediately after you select "On."
- Some DVD videos will allow you to make subtitle selections and turn subtitles on or off only by using the disc menu.

DVD

Selecting a Subtitle Language

You can select a subtitle language from those included on the DVD video.

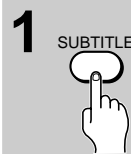

1 Press SUBTITLE during playback.
The current subtitle setting is displayed for about 3 seconds.

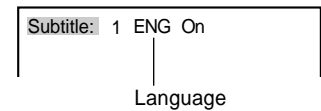

The abbreviation of the language appears instead of the language name. See the list of languages and their abbreviations on page 36.

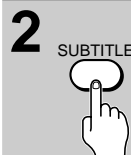

2 Press SUBTITLE or ▲ while the subtitle setting is displayed on the TV screen.

Each time you press SUBTITLE or ▲, the subtitle language changes to the next language included on the DVD video.

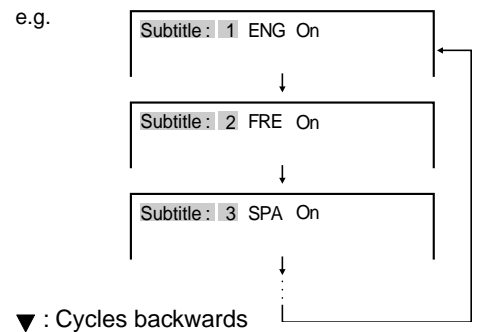

■ To turn off the subtitle setting display



Press CLEAR.

Notes

- When you turn on the DVD Player or replace a disc, the DVD Player returns to the automatic setting in the setting menu (see pages 28 and 30).
When you select a subtitle language which is not included on the disc, the DVD Player plays the prior language programmed on the disc.
- During some scenes, the subtitles may not appear immediately after you change the subtitle language by pressing ▲/▼.

Selecting the Audio Language and Sound System as a set

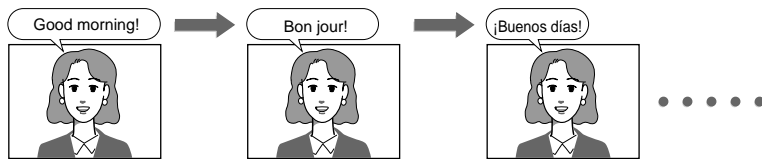

You can select a preferred audio language and sound system.

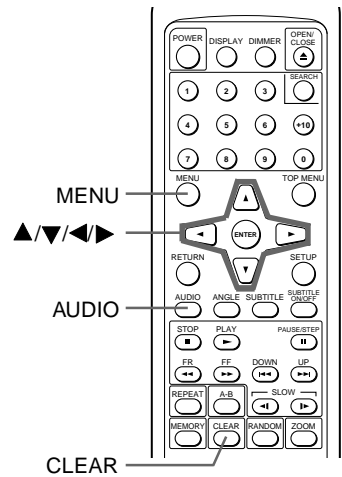

DVD

Selecting a Playback Audio Setting

You can select the preferred audio language and sound system as a set from those included on the DVD video. This function lets you temporarily change the audio language which you selected as the automatic setting in the setting menu (see pages 28 and 30), and choose the sound system if the DVD video is recorded in more than one sound format.



Press AUDIO during playback.

The current audio setting is displayed for about 3 seconds.

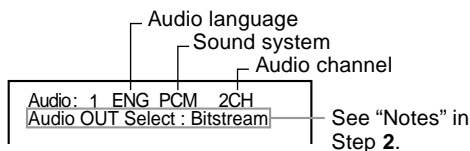

The abbreviation of the language appears. Refer to the list of languages on page 36.



Press AUDIO or ▲ while the audio setting is displayed on the TV screen.

Each time you press AUDIO or ▲, the language and audio recording system set changes.

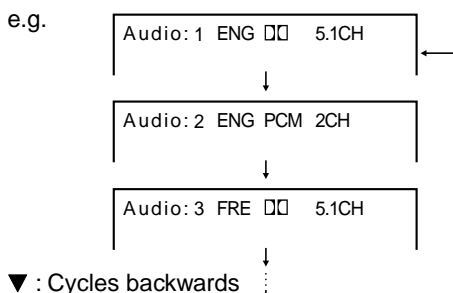

Notes

- Dolby Digital 5.1 Channel sound may be displayed as "□□ 6CH."
 - You can change the "Audio Out Select" setting temporarily by pressing ◀▶.
- Before changing the setting, read through the explanation on "Audio Out Select" on page 32 and carefully select the setting.

Notes

- Some discs allow you to change audio selections only by using the disc menu. If this is the case, press MENU and choose the appropriate language from the selections in the disc menu.
- Some discs may have only one audio language and sound recording system set and you cannot change this selection.
- When you turn on the DVD Player or replace a disc, the DVD Player returns to the automatic setting in the setting menu (see page 28).

■ **To turn off the audio setting display**



Press CLEAR.

VCD

Selecting Sound Channels on VIDEO CDs

A VIDEO CD may have left and right sound channels which contain sounds or languages on each channel. You can switch these two channels to hear a preferred sound or language.



During playback, press AUDIO (repeatedly) to select the sound channel.

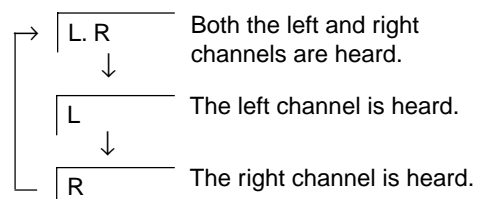

Using Information on the On-Screen Display and the DVD Player's Display

You can view information about a disc and its operational status on the TV screen and the DVD Player's display.

Note

Some DVD videos may not display the chapter number or elapsed time.

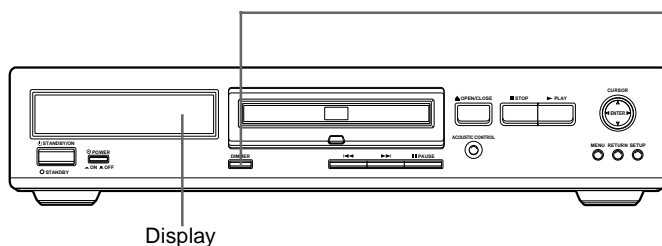

DVD VCD CD

Checking the Total Number of the Titles/Tracks, Current Title/Chapter/Track, Remaining and Elapsed Time, etc.

When the disc is inserted in the DVD Player

The following information appears in the DVD Player's display for about five seconds.

DVD video*

e.g.

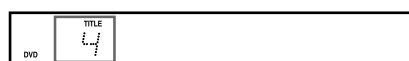

Total number of titles

* Playback may automatically start depending on the DVD video. In this case, the information on the left doesn't appear.

VIDEO CD/Audio CD

e.g.

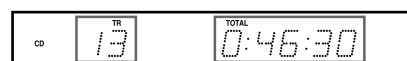

Total number of tracks

Total playing time of the disc

DISPLAY



Press DISPLAY while the disc is stopped.

Each time you press DISPLAY, the on-screen display on the TV screen changes as follows.

DVD video

e.g.

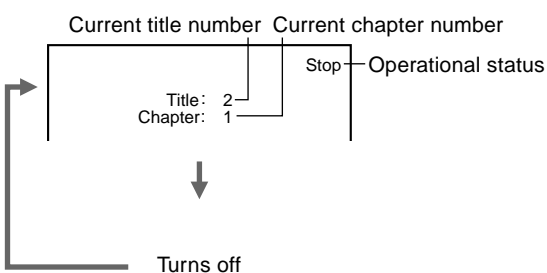

VIDEO CD/Audio CD

e.g.

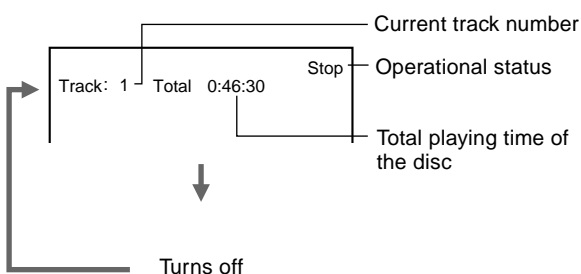

Each time you press DISPLAY, the DVD Player's display changes as follows.

DVD video

e.g.

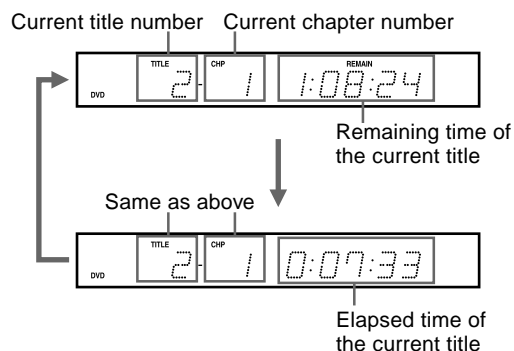

VIDEO CD/Audio CD

e.g.

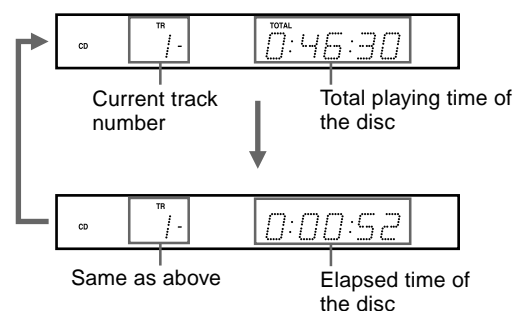

Dimming the DVD Player's Display

Press DIMMER.

To resume the original brightness, press the button again.

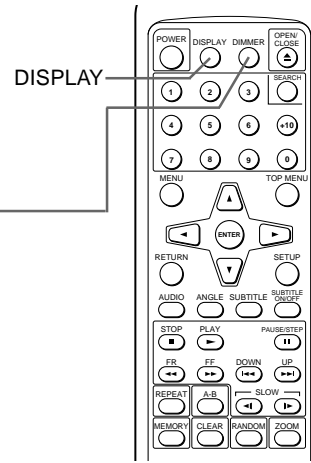

DISPLAY



Press DISPLAY during playback.

Each time you press DISPLAY, the on-screen display on the TV screen changes as follows.

DVD video

e.g.

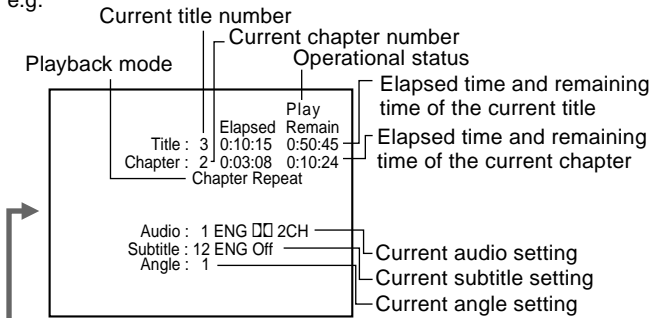

The abbreviation of the language (e.g. ENG) appears instead of the language name. See the list of languages and their abbreviations on page 36.

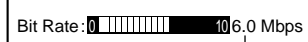

Data transfer rate (Mbit/s):
The amount of picture, sound and subtitle data in the DVD video transferred per second.
The larger the value is, the faster data is processed, but this does not necessarily ensure better picture quality.

Turns off.

VIDEO CD/Audio CD

e.g.

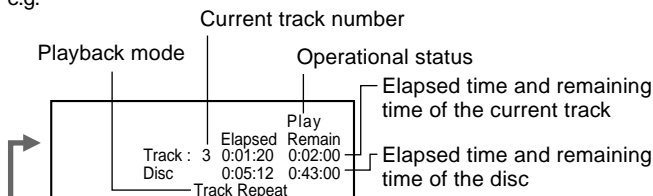

Turns off.

Each time you press DISPLAY, the DVD Player's display changes as follows.

DVD video

e.g.

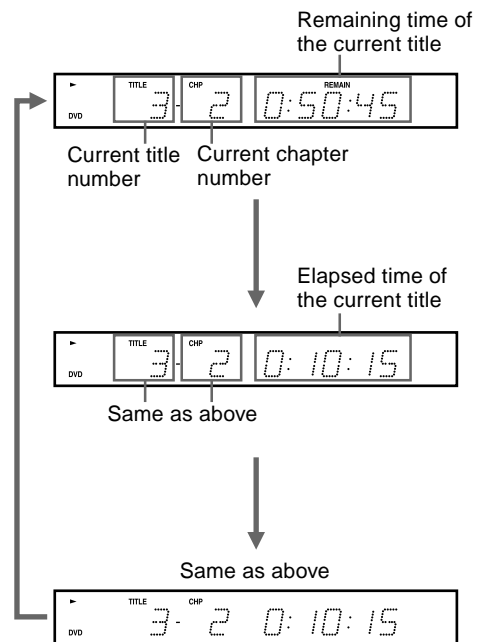

VIDEO CD/Audio CD

e.g.

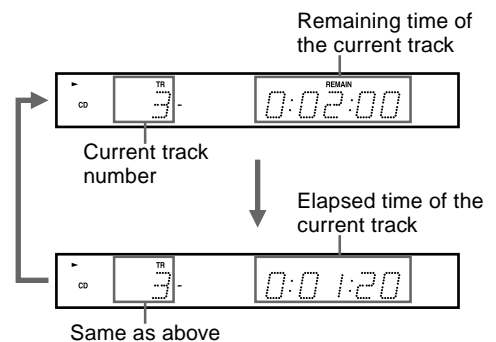

Customizing the Function Settings



When you insert a DVD Video, VIDEO CD, or audio CD, the various functions of the DVD Player will be set (reset) according to the setting menu. You can customize this setting menu according to your preference.

Before operating

SETUP can function even during normal playback. However, if an operation is inaccessible, a message will appear. In this case, try again after playback is stopped.

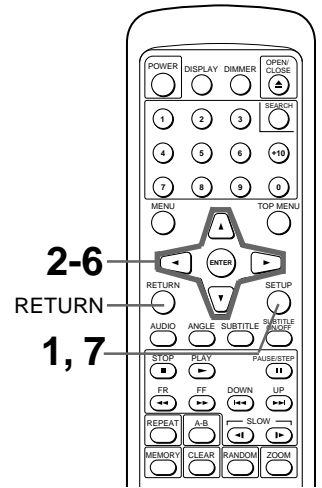

DVD VCD CD

Setting Steps



1 Press SETUP.
The following setting menu appears.

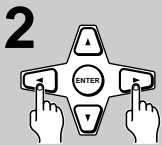
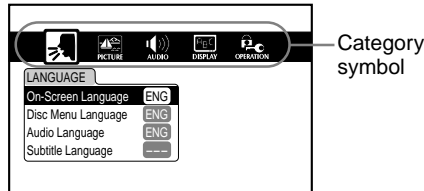

2 Press ◀▶ to select a category symbol for the setting you want to change.

- Setting languages
- Setting playback picture conditions
- Setting sound output
- Setting displays
- Setting operational options

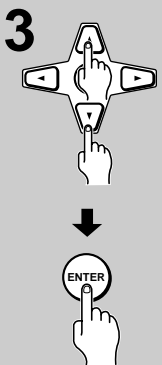

3 Press ▲/▼ to select the item you want to change, then press ENTER.

e.g. When you select "PICTURE" as the category in step 2, then select "TV Shape" as the item in this step.

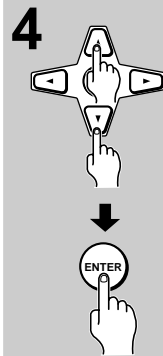
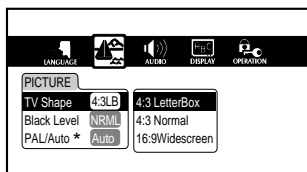

4 Press ▲/▼ to change the setting, the press ENTER.

e.g. When you change the "TV Shape" setting to "16:9Widescreen."

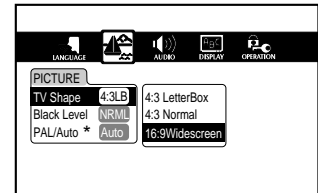

5 Further steps may be needed depending on the item or setting. Follow the steps described in the explanation of each item starting from page 30.

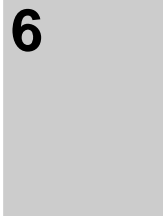

- To change the setting of other items in the same category, repeat steps 3 to 5.
- To change the setting of an item in a different category, repeat steps 2 to 5.



7 To close the setting menu, press SETUP.

■ To return to the previously displayed menu







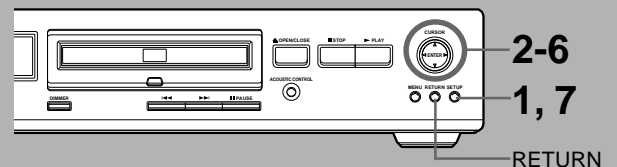





























Press RETURN.

When operating with the DVD Player



Reference Table of the Setting Menu

Category Symbol	Menu item	Related to	Details	Page
	On-Screen Language	  	To select a preferred language for on-screen displays	30
	Disc Menu Language		To select a preferred language for disc menus	30
	Audio Language		To select a preferred language for the sound track	30
	Subtitle Language		To select a preferred language for subtitles	30
	TV Shape		To select a picture size according to the aspect ratio of your TV	31
	Black Level	 	To select the black level of playback picture	31
	PAL/Auto*	 	To select the video system of a disc	31
	Audio Out Select	  	To select a sound signal conversion method according to your purpose and preference	32
	Dynamic Range Control		To turn on or off a function that makes faint sounds easier to hear even if you lower the volume during late night playback	33
	Karaoke Vocal		To turn on or off the vocal output during KARAOKE disc playback	33
	Extended Audio Feature		To turn on or off narration for visually impaired persons	33
	On-Screen Displays	  	To turn on or off the operational status display (On-screen display) on the TV screen	33
	OSD Background Color	  	To select the background color for on-screen displays	33
	Extended Subtitle Features		To turn on or off special subtitles for hearing impaired persons	33
	Screen Saver		To turn on or off the screen saver	33
	Pause/Still		To select the resolution of still pictures (Field/Frame)	34
	Parental Lock		To turn on or off the parental lock function	34
	Title Stop		To turn on or off a feature that automatically stops playback after a title has finished	35
	PBC		To use the menu screen when playing a PBC-controllable VIDEO CD	35

* Not applicable for USA and Canadian models

Customizing the Function Settings

Explanation of Each Item in the Language Category

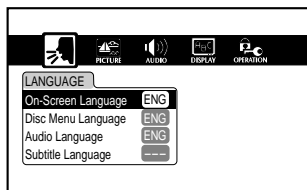

Note

To know the factory setting for each item, see the on-screen illustration on the left.

On-Screen Language



Select an on-screen language from the following:

- | | |
|-----------------------|-----------------------|
| (Asian models) | (Other models) |
| • English | • English |
| • Chinese | • French |
| • Malaysian | • Spanish |

Disc Menu Language



Select a disc menu language from the following:

- | | |
|-----------------------|-----------------------|
| (Asian models) | (Other models) |
| • English | • English |
| • Chinese | • French |
| • Malaysian | • Spanish |

(All models)

- **Others** → Continue to “Choosing Another Language” in the right column of this page.

Note

Some DVD videos may not include your pre-selected language. In this case, the DVD Player automatically displays disc menus consistent with the disc’s initial language setting.

Audio Language



Select an audio language from the following:

- | | |
|-----------------------|-----------------------|
| (Asian models) | (Other models) |
| • English | • English |
| • Chinese | • French |
| • Malaysian | • Spanish |

(All models)

- **Others** → Continue to “Choosing Another Language” in the right column of this page.

Note

Some DVD videos may be played in a different language than you selected because an initial language may be programmed on the disc.

Subtitle Language



Select a subtitle language or no subtitle setting from the following:

- | | |
|-----------------------|-----------------------|
| (Asian models) | (Other models) |
| • English | • English |
| • Chinese | • French |
| • Malaysian | • Spanish |

(All models)

- **No Subtitles:** Select this when you disable subtitles.
- **Others** → Continue to “Choosing Another Language” below.

Notes

- Some DVD videos may be set to display subtitles in a different language than you selected.
- Some DVD videos allow you to change subtitle selections only by using the disc menu. If this is the case, press MENU and choose the appropriate subtitle language from the selection on the disc menu.

Choosing Another Language

After pressing ENTER in step 4 of “Setting Steps” on page 28:

- 1 Obtain the abbreviation of the preferred language from the Table of Languages on page 36.
- 2 Select the first character of the abbreviation by pressing ▲/▼.
 e.g. (USA and Canadian models) When you select “Others” in “Disc Menu Language.”
- 3 Press ◀▶ to move the cursor to the next column, then select the second character of the abbreviation by pressing ▲/▼.
- 4 Press ENTER.

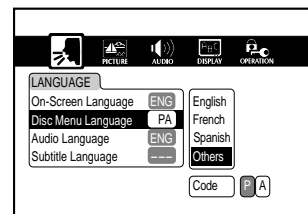

Explanation of Each Item in the Picture Category

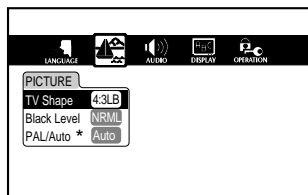

Note

To know the factory setting for each item, see the on-screen illustration on the left.

TV Shape



- **4:3 Letterbox:** Select when a 4:3 TV is connected.



Displays widescreen images with masking bars above and below the picture.

- **4:3 Normal:** Select when a 4:3 TV is connected.



Displays pictures cropped to fill your TV screen. Either or both sides of the picture are cut off.

- **16:9 Widescreen:** Select when a 16:9 wide TV is connected.

Notes

- The displayable picture size is preset on each DVD video. Therefore, the playback picture of some DVD videos may not conform to the picture size you select.
- When you play a DVD video recorded in the 4:3 picture size only, the playback picture always appears in the 4:3 picture size regardless of the TV shape setting.
- If you select "16:9Widescreen" and you own a 4:3 TV set, the DVD playback picture will be horizontally distorted during playback. Images will appear to be horizontally compressed. Make sure the TV Shape conforms to the actual TV in use.

Black Level



Set according to your preference and the TV's capability.

(USA, Canadian, and Asian models)

- **Enhanced:** Expanded black level
- **Normal:** Standard black level

(Other models)

- **Normal:** Standard black level
- **Light:** Brighter than in "Normal"

PAL/Auto*



- **PAL:** Select to play PAL discs. Connect a PAL TV to view pictures.
- **Auto:** The DVD Player automatically detects PAL and NTSC video systems of discs. Connecting a multisystem TV (PAL/NTSC compatible) is needed to view pictures.

Note

A playback picture may be distorted temporarily when the detected signal changes between PAL and NTSC on the disc.

* Not applicable for USA and Canadian models

Customizing the Function Settings

Explanation of Each Item in the Audio Category

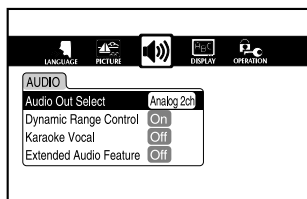

Note

To know the factory setting for each item, see the on-screen illustration on the left.

Audio Out Select



The output sound format can be changed by changing the setting of “Audio Out Select” — the sound signal conversion method.

This setting is related to the equipment connected to the DVD Player’s DIGITAL OUTPUT connectors/ ANALOG OUTPUT jacks (see pages 8 and 9). For details, see “Output Sound Conversion Table” below.

- **Bitstream:** Select when you make the digital connection with an amplifier with a Dolby Digital/DTS/MPEG1/MPEG2*/ Dolby Pro Logic decoder.

Warning

DO NOT set “Audio Out Select” to “Bitstream” if the amplifier does not have one of the decoders described above. If you do so, high volume sound may be output and damage your hearing as well as the speakers.

- **Analog 2ch:** Select when you make only the analog connection. This setting must be made to reproduce Dolby Pro Logic surround sound with the analog connection.

- **PCM:** Select when you make the digital connection with the 2 channel digital stereo.

The Dolby Digital, MPEG1, and MPEG2* sound signals are converted into PCM 2ch format and output from the DIGITAL OUTPUT connectors.

■ Output Sound Conversion Table

Discs	Sound systems	DIGITAL OUT			ANALOG OUT		
		Digital output signals from the DIGITAL OUTPUT COAXIAL/OPTICAL connectors			kHz/bit when converting Digital Signals to Analog Signals for Analog jacks		
		“Audio Out Select” setting			“Audio Out Select” setting		
		Bitstream	Analog 2ch	PCM	Bitstream	Analog 2ch	PCM
DVD videos	DOLBY DIGITAL	Bitstream		48 kHz/16 bit	48 kHz/20 bit	48 kHz/20 bit	48 kHz/20 bit
	Linear PCM	Same kHz/bit as the source			48 kHz/16 bit	48 kHz/16 bit	48 kHz/16 bit
		48 kHz/16 bit	48 kHz/16 bit	No signal is output.	48 kHz/16 bit	48 kHz/20 bit	48 kHz/20 bit
		48 kHz/20 bit			48 kHz/24 bit	48 kHz/20 bit	
		48 kHz/24 bit			96 kHz/16 bit	48 kHz/16 bit	
		96 kHz/16 bit			96 kHz/20 bit	48 kHz/16 bit	
96 kHz/20 bit	96 kHz/24 bit	48 kHz/20 bit					
	DTS	Bitstream		No signal	(No signal is output.)		
	MPEG2*	Bitstream (7.1ch)	Bitstream (2ch)	48 kHz/16 bit	(No signal is output.)	48 kHz/16 bit	
VIDEO CDs	MPEG1	44.1 kHz/16 bit			44.1 kHz/16 bit		
Audio CDs	Linear PCM 44.1 kHz/16 bit	Same kHz/bit as the source			44.1 kHz/16 bit		
	DTS	Bitstream			(Noise is output.)		

* Not applicable for USA and Canadian models

Explanation of Each Item in the Display Category

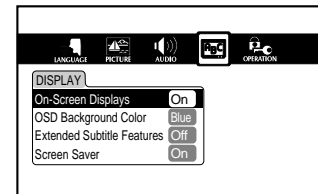
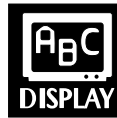

Dynamic Range Control

- **Off:** Full dynamic range is maintained.
- **On:** Dynamic range is reduced.

Notes

- This function works only with playback of Dolby Digital recorded discs.
- The level of Dynamic Range Reduction may differ depending on the DVD video.

Karaoke Vocal

The vocal output feature is used during playback of Dolby Digital (multichannel) recorded DVD KARAOKE discs. This feature allows you to turn off vocal audio tracks, or restore them for background accompaniment.

- **Off:** The primary vocal is not output.
- **On:** The primary vocal is output if it is recorded on the disc.

Note

The amplifier with a Dolby Digital decoder must be connected to the DVD Player.

Extended Audio Feature















Some DVD videos contain a narration track for visually impaired persons. The DVD player automatically plays the narration track by setting this item to "On."

- **Off:** The narration track is not played.
- **On:** The narration track is played automatically.

Note

To know the factory setting for each item, see the above on-screen illustration.

On-Screen displays

- **Off:** Operational modes are not displayed on the TV screen.
- **On:** Operational modes are displayed on the TV screen (e.g. "PLAY", , , , , , , , , , , , , , , ).

OSD Background Color

- **Blue:** Blue background.
- **Gray:** Gray background.

Extended Subtitle Features

Some DVD videos contain special subtitles, an enhancement of closed captions for hearing impaired persons. The DVD Player automatically displays these special subtitles by setting this item to "On."

- **Off:** The extended subtitles are not displayed.
- **On:** The extended subtitles are displayed automatically.

Screen Saver

- **Off:** The screen saver is disabled.
- **On:** The screen saver is enabled.

Customizing the Function Settings

Explanation of Each Item in the Operation Category

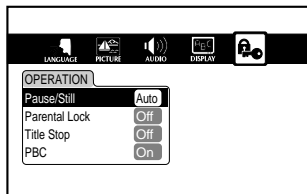

Note

To know the factory setting for each item, see the on-screen illustration on the left.

Pause/Still



- **Auto:** Select for normal use. The image can be paused without shaking.
- **Frame:** The resolution of the still pictures is improved so that you can make a motionless picture clearer when you pause it.

Parental Lock



DVD videos equipped with the parental lock function are rated according to their content. The content allowed by a parental lock level and the way a DVD video can be controlled may vary from disc to disc. For example, some discs allow you to edit out violent scenes unsuitable for children and replace them with more suitable scenes, or lock out playback of the disc altogether.

- Off:** Select to disable the parental lock feature. Then, carry out "Further Steps" in the right column of this page.
- On:** Select to activate the parental lock feature or change the settings. Then, carry out "Further Steps" in the right column of this page.

Note

DVD videos may or may not respond to the parental lock settings. This is not a defect in the DVD Player. Make sure this function works with your DVD videos.

Further Steps

After pressing ENTER in step 4 of "Setting Steps" on page 28,

- 1 Press the number buttons to create a personal 4-digit security code, then press ENTER.

(To reenter the security code, before pressing ENTER, press CLEAR then enter the security code.)

- **When you select "Parental Lock On"**
Continue to the next step.
- **When you select "Parental Lock Off"**
The parental lock is disabled.

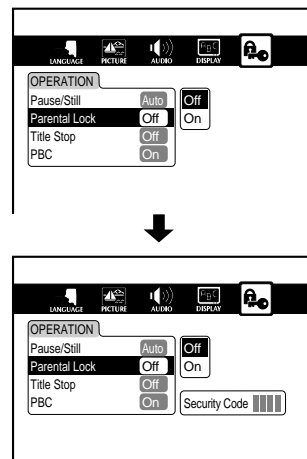

- 2 Press ◀▶ to select the country whose standards were used to rate the DVD video.

e.g. USA and Canadian models

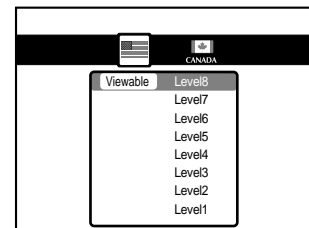

- 3 Press ▲▼ to select the parental lock level, then press ENTER.

e.g. USA and Canadian models

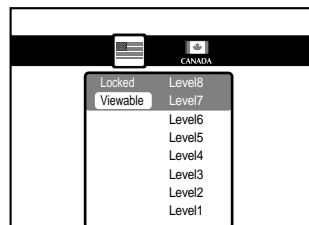

The parental lock is activated.

You cannot play DVD videos rated higher than the level you select unless you cancel the parental lock function. For example, when you select level 7, discs rated higher than level 7 are locked out and cannot be played.

■ To change the parental lock level

Follow the above procedure.

■ To change your 4-digit security code

After selecting “On” or “Off” and pressing ENTER in step 4 of “Setting Steps” on page 28:

- 1 Press STOP four times, then press ENTER.



The 4-digit security code is cleared.

- 2 Press the number buttons to create a new 4-digit security code.
- 3 Press ENTER.

Title Stop



- **Off:** The DVD Player continues playback after playback of a title is complete.
- **On:** The DVD Player stops playback after playback of a title is complete.

PBC



PBC is the abbreviation for Playback Control (see “About VIDEO CDs” on page 11.)

- **Off:** Select to play a PBC-featured VIDEO CD without using the menu screen.
- **On:** Select to view the menu screen when playing a PBC-featured VIDEO CD.

Table of Languages

Table of Languages and Their Abbreviations

Abbreviation of the Language	Language	Abbreviation of the Language	Language	Abbreviation of the Language	Language	Abbreviation of the Language	Language
—	No alternate language	EO	Esperanto	LN	Lingala	SL	Slovenian
CHI (ZH)	Chinese	ET	Estonian	LO	Laotian	SM	Samoan
DUT (NL)	Dutch	EU	Basque	LT	Lithuanian	SN	Shona
ENG (EN)	English	FA	Persian	LV	Latvian, Lettish	SO	Somali
FRE (FR)	French	FI	Finnish	MG	Malagasy	SQ	Albanian
GER (DE)	German	FJ	Fiji	MI	Maori	SR	Serbian
ITA (IT)	Italian	FO	Faroese	MK	Macedonian	SS	Siswati
JPN (JA)	Japanese	FY	Frisian	ML	Malayalam	ST	Sesotho
KOR (KO)	Korean	GA	Irish	MN	Mongolian	SU	Sundanese
MAY (MS)	Malay	GD	Scottish, Gaelic	MO	Moldavian	SV	Swedish
SPA (ES)	Spanish	GL	Galician	MR	Marathi	SW	Swahili
AA	Afar	GN	Guarani	MT	Maltese	TA	Tamil
AB	Abkhazian	GU	Gujarati	MY	Burmese	TE	Telugu
AF	Afrikaans	HA	Hausa	NA	Nauru	TG	Tajik
AM	Amharic	HI	Hindi	NE	Nepali	TH	Thai
AR	Arabic	HR	Croatian	NO	Norwegian	TI	Tigrinya
AS	Assamese	HU	Hungarian	OC	Occitan	TK	Turkmen
AY	Aymara	HY	Armenian	OM	(Afan) Oromo	TL	Tagalog
AZ	Azerbaijani	IA	Interlingua	OR	Oriya	TN	Setswana
BA	Bashkir	IE	Interlingue	PA	Panjabi	TO	Tongan
BE	Belorussian	IK	Inupiak	PL	Polish	TR	Turkish
BG	Bulgarian	IN	Indonesian	PS	Pashto, Pushto	TS	Tsonga
BH	Bihari	IS	Icelandic	PT	Portuguese	TT	Tatar
BI	Bislama	IW	Hebrew	QU	Quechua	TW	Twi
BN	Bengali, Bangla	JI	Yiddish	RM	Rhaeto-Romance	UK	Ukrainian
BO	Tibetan	JW	Javanese	RN	Kirundi	UR	Urdu
BR	Breton	KA	Georgian	RO	Rumanian	UZ	Uzbek
CA	Catalan	KK	Kazakh	RU	Russian	VI	Vietnamese
CO	Corsican	KL	Greenlandic	RW	Kinyarwanda	VO	Volapük
CS	Czech	KM	Cambodian	SA	Sanskrit	WO	Wolof
CY	Welsh	KN	Kannada	SD	Sindhi	XH	Xhosa
DA	Danish	KS	Kashmiri	SG	Sango	YO	Yoruba
DZ	Bhutani	KU	Kurdish	SH	Serbo-Croatian	ZU	Zulu
EL	Greek	KY	Kirghiz	SI	Singhalese		
		LA	Latin	SK	Slovak		

Troubleshooting

Check the following guide for the possible cause of a problem before contacting service. Refer also to the respective instruction manuals of the connected components and TV.

	Symptoms	Causes	Remedies	Pages
DVD Player	The DVD Player doesn't switch on.	<ul style="list-style-type: none"> The power cord is disconnected. The main power is set to OFF. There is external noise in the computer circuits of the DVD Player. The AC fuse is blown. 	<ul style="list-style-type: none"> Check the connection of the power cord. Turn on the main power. Switch off the main power, then switch it on again. If not recovered, disconnect the power cord, then connect it again. Contact your nearest ONKYO service center. 	10 10 10 –
	The DVD Player does not start playback.	<ul style="list-style-type: none"> No disc is inserted. The region number of the disc does not match that of the DVD Player. An unplayable disc is inserted. The disc is placed upside down. The disc is not placed within the disc tray guide. The disc is dirty. The parental lock function is activated. 	<ul style="list-style-type: none"> Insert a disc. (Check that "DVD," "VCD," or "CD" is lit in the DVD Player's display.) See "1. Regional Restriction Codes (Region Number)" on page 4. Check the playable discs. Place the disc with the playback side down. Place the disc within the proper guide on the disc tray. Eject the disc and clean it. Deactivate the parental lock function or change the parental lock level. 	12 4 11 12 12 11 34
	Brightness is unstable or noise is visible on the playback picture.	<ul style="list-style-type: none"> Copy protection is activated. 	<ul style="list-style-type: none"> Connect the DVD Player directly to the TV. Avoid connecting the DVD Player to the TV through a VCR. 	8
	The playback picture is occasionally distorted.	<ul style="list-style-type: none"> The disc is dirty. It is in fast forward or fast reverse playback. 	<ul style="list-style-type: none"> Eject the disc and clean it. Sometimes a small amount of picture distortion may appear. This is not a malfunction. 	11 14
	Playback doesn't follow the course of the disc's programs.	<ul style="list-style-type: none"> The DVD Player is in repeat playback mode, memory playback mode, or random playback mode, etc. 	<ul style="list-style-type: none"> Resume normal playback. 	19-21
	The picture from the DVD Player doesn't appear on the TV screen.	<ul style="list-style-type: none"> The TV is not set to receive the output signals from the DVD Player. The DVD Player is not properly connected. 	<ul style="list-style-type: none"> Set the TV to the DVD Player's input. Check the connections to the DVD Player. 	12 8
	No sound is reproduced.	<ul style="list-style-type: none"> A wrong sound signal conversion method (Audio Out Select) is selected. The TV is not set to receive the output signals from the DVD Player. The DVD Player is not properly connected. 	<ul style="list-style-type: none"> Check the current sound signal conversion method, and select the right setting for "Audio Out Select." Set the TV to the DVD Player's input. Check the connections to the DVD Player. 	32 12 8, 9
	The buttons on the remote controller and DVD Player do not operate.	<ul style="list-style-type: none"> Power supply fluctuations or other abnormalities such as static electricity may interrupt correct operation. 	<ul style="list-style-type: none"> Switch off the main power, then switch it on again. If not recovered, disconnect the power cord, then connect it again. 	10
Remote Controller	The buttons on the DVD Player operate but the buttons on the remote controller do not operate.	<ul style="list-style-type: none"> No batteries are inserted in the remote controller. The batteries are worn out. The remote controller is not pointed at the remote sensor of the DVD Player. The remote controller is too far from the DVD Player. 	<ul style="list-style-type: none"> Insert new batteries. Replace with new batteries. Point the remote controller at the remote sensor of the DVD Player. Operate the remote controller within 5 m (16 feet). 	7 7 7 7

Because the unit contains a microcomputer to provide advanced functions, it may malfunction due to external noise or static electricity. If this happens, press the POWER switch on the unit and then press it again after about five seconds.

Specifications

■ DVD Player

Power supply	USA and Canadian models: AC 120 V, 60 Hz Other models: AC 100–240 V, 50/60 Hz
Power consumption	USA and Canadian models: 21 W Other models: 19 W
Weight	3.8 kg, 8.4 lbs.
External dimensions	435 × 91 × 300 mm (W/H/D), 17 1/8" × 3 9/16" × 11 13/16" (W/H/D)
Signal system	USA and Canadian models: Standard NTSC Other models: PAL/3.58 NTSC
Regional restriction code	USA and Canadian area : 1 Australasian area : 4 South-east Asian area : 3 PRC : 6
Laser	Semiconductor laser, wavelength 650 nm
Frequency range (digital audio)	DVD linear sound: 48 kHz sampling 4 Hz to 22 kHz 96 kHz sampling 4 Hz to 44 kHz Audio CD: 4 Hz to 20 kHz
Signal-to-noise ratio (digital audio)	More than 100 dB
Audio dynamic range (digital audio)	More than 96 dB
Harmonic distortion (digital audio)	Less than 0.01 %
Wow and flutter	Below measurable level (less than ±0.001 % (W.PEAK))
Operating conditions	Temperature: 5°C to 35°C (41°F to 95°F), Operation status: Horizontal

■ Outputs

Component video output	(Y) 1.0 V (p-p), 75 Ω, pin jack × 1 (P _B)/(P _R) 0.7 V (p-p), 75 Ω, pin jack × 1
Video output	1.0 V (p-p), 75 Ω, negative sync., pin jack × 1
S video output	(Y) 1.0 V (p-p), 75 Ω, negative sync., Mini DIN 4-pin × 1 (C) 0.286 V (p-p), 75 Ω
Audio output (OPTICAL)	–22.5 dBm × 1
Audio output (COAXIAL)	0.5 V (p-p), 75 Ω, pin jack × 1
Audio output (ANALOG DIRECT)	2.0 V (rms), 470 Ω, pin jack (L, R) × 1
Audio output (ACOUSTIC CONTROL)	2.0 V (rms), 470 Ω, pin jack (L, R) × 1
Audio output (MONO DIRECT)	2.0 V (rms), 470 Ω, pin jack × 1

Index to Parts and Controls

For operational instructions, see the page indicated in brackets [].

■ Rear panel

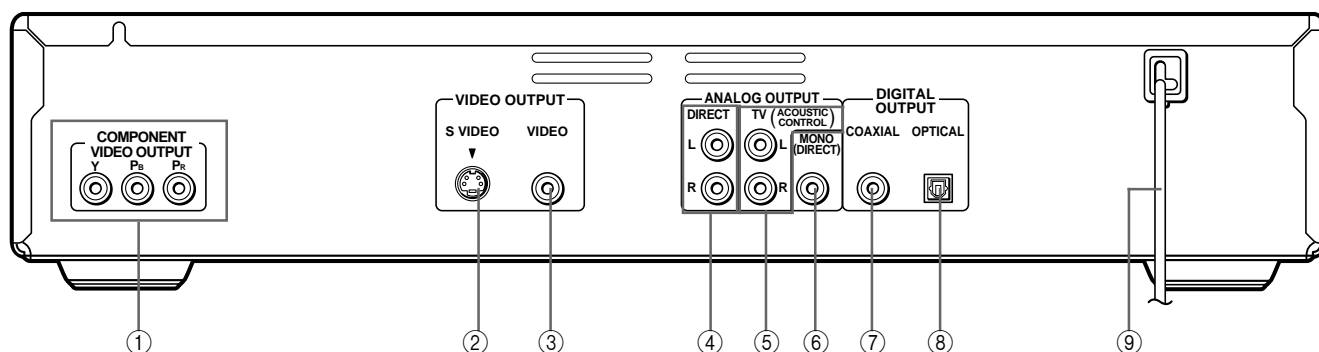

① COMPONENT VIDEO OUTPUT (Y/P_B/P_R) jacks [8]

② VIDEO OUTPUT
S VIDEO connector [8]

③ VIDEO OUTPUT
VIDEO connector [8]

④ ANALOG OUTPUT
DIRECT L/R jacks [9]

⑤ ANALOG OUTPUT
TV (ACOUSTIC CONTROL) L/R jacks [8]

⑥ ANALOG OUTPUT
MONO (DIRECT) jack [9]

⑦ DIGITAL OUTPUT
COAXIAL connector [9]

⑧ DIGITAL OUTPUT
OPTICAL connector [9]

⑨ Power cord [10]

Index to Parts and Controls

■ Front panel

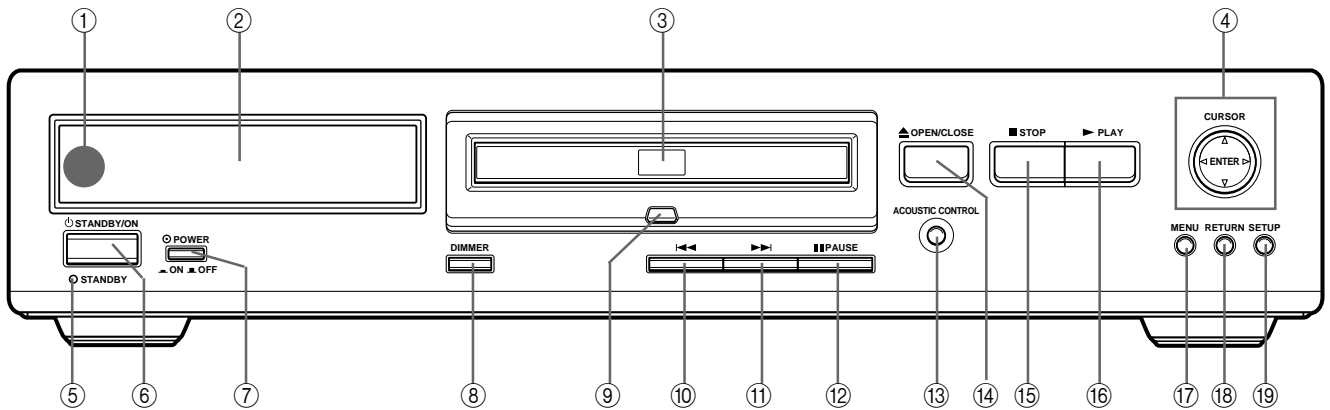

- ① Remote control sensor [7]
- ② Display [26, 27, 41]
- ③ DVD/VIDEO CD/CD disc tray [12]
- ④ CURSOR (▲/▼/◀/▶) / ENTER [10, 15, 28]
- ⑤ STANDBY indicator [7, 10]
- ⑥ STANDBY/ON button [10]
- ⑦ POWER switch [10]
- ⑧ DIMMER button [26, 27]
- ⑨ Disc indicator [12]
- ⑩ ◀◀ button [18]

- ⑪ ▶▶ button [18]
- ⑫ || PAUSE button [13]
- ⑬ ACOUSTIC CONTROL button/indicator [14]
- ⑭ ▲ OPEN/CLOSE button [12, 13]
- ⑮ ■ STOP button [13]
- ⑯ ▶ PLAY button [12]
- ⑰ MENU button [15]
- ⑱ RETURN button [28]
- ⑲ SETUP button [10, 28]

■ Display

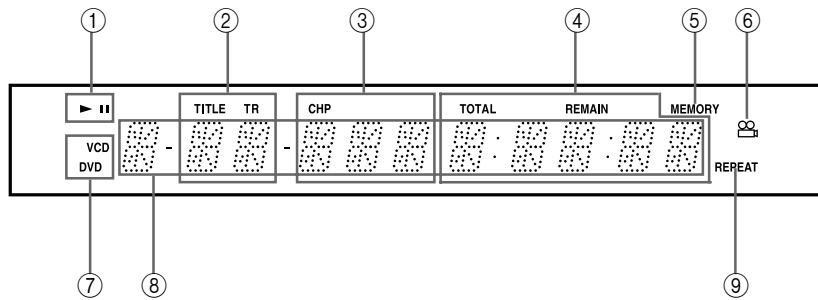

- ① Operating status indicator
- ② Title/track number indicator [26, 27]
- ③ Chapter number indicator [26, 27]
- ④ Total playing time/remaining time/elapsed time indicators [26, 27]
- ⑤ MEMORY indicator [20]
- ⑥ Angle icon indicator [23]
- ⑦ Inserted disc indicator [12]
- ⑧ Multifunctional indicator (e.g. operating status and error messages)
- ⑨ REPEAT indicator [19]

Index to Parts and Controls

■ Remote controller

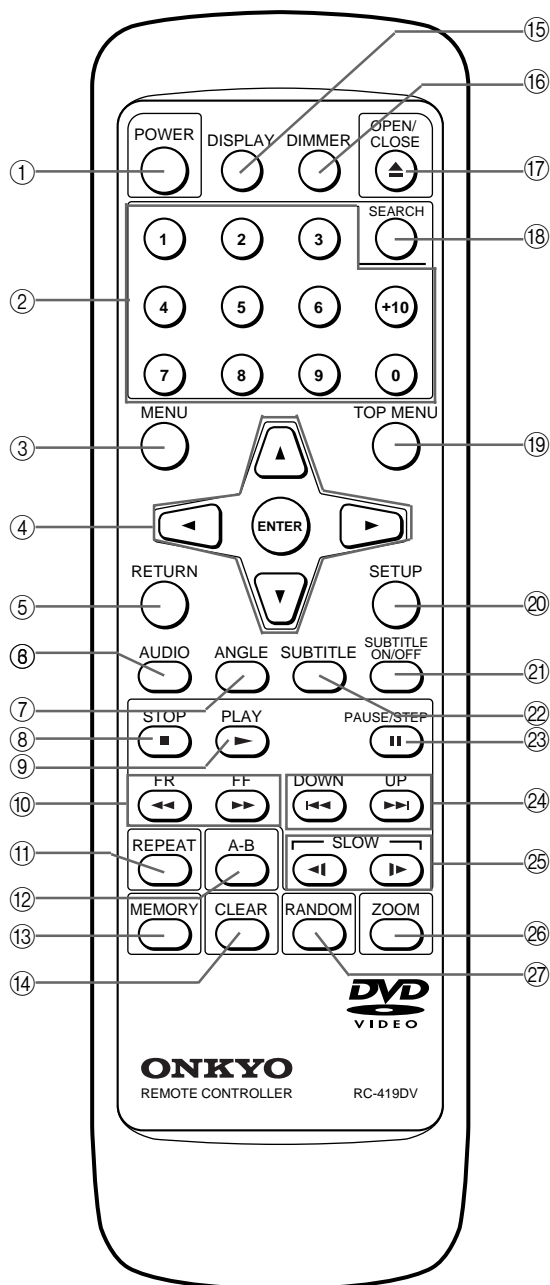

- ① **POWER** button [10]
- ② **Number** buttons [16]
- ③ **MENU** button [15, 16, 25]
- ④ **▲/▼/◀▶** **ENTER** buttons [10, 15, 16, 28]
- ⑤ **RETURN** button [20, 22, 28]
- ⑥ **AUDIO** button [25]
- ⑦ **ANGLE** button [23]
- ⑧ **■ (STOP)** button [13, 35]
- ⑨ **▶ (PLAY)** button [12]
- ⑩ **◀◀ (FR)/▶▶ (FF)** buttons [14]
- ⑪ **REPEAT** button [19]
- ⑫ **A-B** button [19]
- ⑬ **MEMORY** button [20]
- ⑭ **CLEAR** button [19–25]
- ⑮ **DISPLAY** button [20, 26, 27]
- ⑯ **DIMMER** button [27]
- ⑰ **▲ (OPEN/CLOSE)** button [12, 13]
- ⑱ **SEARCH** button [16, 18, 21]
- ⑲ **TOP MENU** button [15, 16]
- ⑳ **SETUP** button [10, 28]
- ㉑ **SUBTITLE ON/OFF** button [24]
- ㉒ **SUBTITLE** button [24]
- ㉓ **|| (PAUSE/STEP)** button [13]
- ㉔ **◀◀ (DOWN)/▶▶ (UP)** buttons [18, 21]
- ㉕ **◀/▶ (SLOW)** buttons [14]
- ㉖ **ZOOM** button [22]
- ㉗ **RANDOM** button [21]

ONKYO CORPORATION

Sales & Product Planning Div. : 2-1, Nisshin-cho, Neyagawa-shi, OSAKA 572-8540, JAPAN
Tel: 072-831-8111 Fax: 072-833-5222 <http://www.onkyo-intl.com>

ONKYO U.S.A. CORPORATION

18 Park Way, Upper Saddle River, N.J. 07458, U.S.A.
Tel: 201-785-2600 Fax: 201-785-2650 <http://www.onkyousa.com>

ONKYO EUROPE ELECTRONICS GmbH

Liegnitzerstrasse 6, 82194 Groebenzell, GERMANY
Tel: +49-8142-4401-0 Fax: +49-8142-4401-555 <http://www.onkyo.net>

ONKYO CHINA LIMITED

Units 2102-2107, Metroplaza Tower I, 223 Hing Fong Road, Kwai Chung,
N.T., HONG KONG Tel: 852-2429-3118 Fax: 852-2428-9039 <http://www.onkyochina.com>

